

Welcome to [E-XFL.COM](https://www.e-xfl.com)

Embedded - Microcontrollers - Application Specific: Tailored Solutions for Precision and Performance

Embedded - Microcontrollers - Application Specific represents a category of microcontrollers designed with unique features and capabilities tailored to specific application needs. Unlike general-purpose microcontrollers, application-specific microcontrollers are optimized for particular tasks, offering enhanced performance, efficiency, and functionality to meet the demands of specialized applications.

What Are Embedded - Microcontrollers - Application Specific?

Application specific microcontrollers are engineered to

Details

Product Status	Active
Applications	Trusted Platform Module (TPM)
Core Processor	AVR
Program Memory Type	EEPROM
Controller Series	-
RAM Size	-
Interface	SPI
Number of I/O	4
Voltage - Supply	3.3V
Operating Temperature	0°C ~ 70°C
Mounting Type	Surface Mount
Package / Case	32-VFQFN Exposed Pad
Supplier Device Package	32-VQFN (4x4)
Purchase URL	https://www.e-xfl.com/product-detail/microchip-technology/at97sc3205-g3m45-20

Trusted Platform Module – SPI Interface

SUMMARY DATASHEET

Features

- Compliant to the Trusted Computing Group (TCG) Trusted Platform Module (TPM) Version 1.2 Specification
- Compliant with TCG PC Client-Specific TPM Interface Specification (TIS) Version 1.3
- Single-chip, Turnkey Solution
- Hardware Asymmetric Crypto Engine
- Atmel® AVR® RISC Microprocessor
- Internal EEPROM Storage for RSA Keys
- Serial Peripheral Interface (SPI) Protocol Up to 45MHz*
(*Typical PC Operating Range is 24MHz to 33MHz)
- Secure Hardware and Firmware Design and Chip Layout
- FIPS-140-2 Module Certified Including the High-quality Random Number Generator (RNG), HMAC, AES, SHA, and RSA Engines
- NV Storage Space for 2066 bytes of User Defined Data
- 3.3V Supply Voltage
- 28-lead Thin TSSOP and 32-pad QFN Package
- Offered in Both Commercial (0°C to 70°C) and Industrial (-40°C to +85°C) Temperature Ranges

Description

The Atmel AT97SC3205 is a fully integrated security module designed to be integrated into personal computers and other embedded systems. It implements version 1.2 of the Trusted Computing Group (TCG) specification for Trusted Platform Modules (TPM).

**This is a summary document.
The complete document is
available under NDA. For more
information, please contact
your local Atmel sales office.**

1. Pin Configurations and Pinouts

Table 1-1. Pin Configurations

Pin Name	Function
V _{CC}	3.3V Supply Voltage
GND	Ground
GPIO Express-00	GPIO assigned to TPM_NV_INDEX_GPIO_00
PP/GPIO	Hardware Physical Presence or GPIO pin.
GPIO	General Purpose Input/Output Pin
MISO	SPI Slave Data Output
MOSI	SPI Slave Data Input
PIRQ#	SPI Interrupt Requests
SPI_CLK	SPI Clock Input
SPI_CS#	SPI Chip Select
SPI_RST#	SPI Reset Pin
TestI	TestI Manufacturing Test Input (Disabled)
TestBI	TestBI Manufacturing Test Input (Disabled)
XTamper	Indicate External Tamper Event
NC	No Connect

Figure 1-1. Pinouts

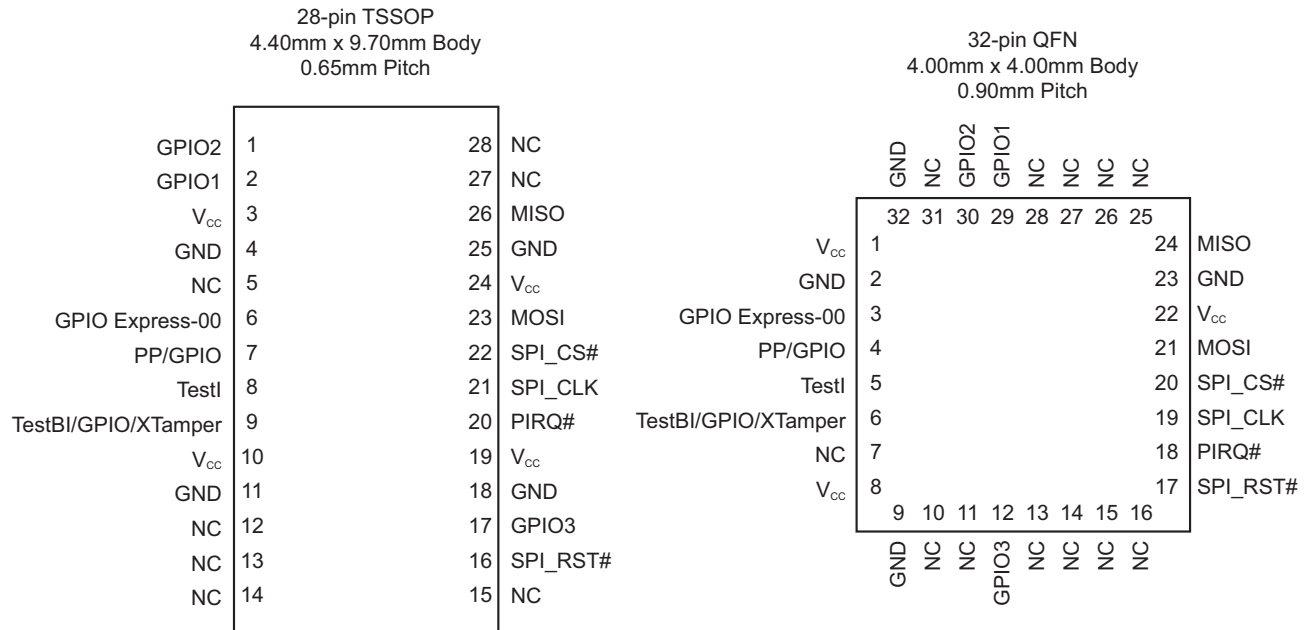

2. Block Diagram

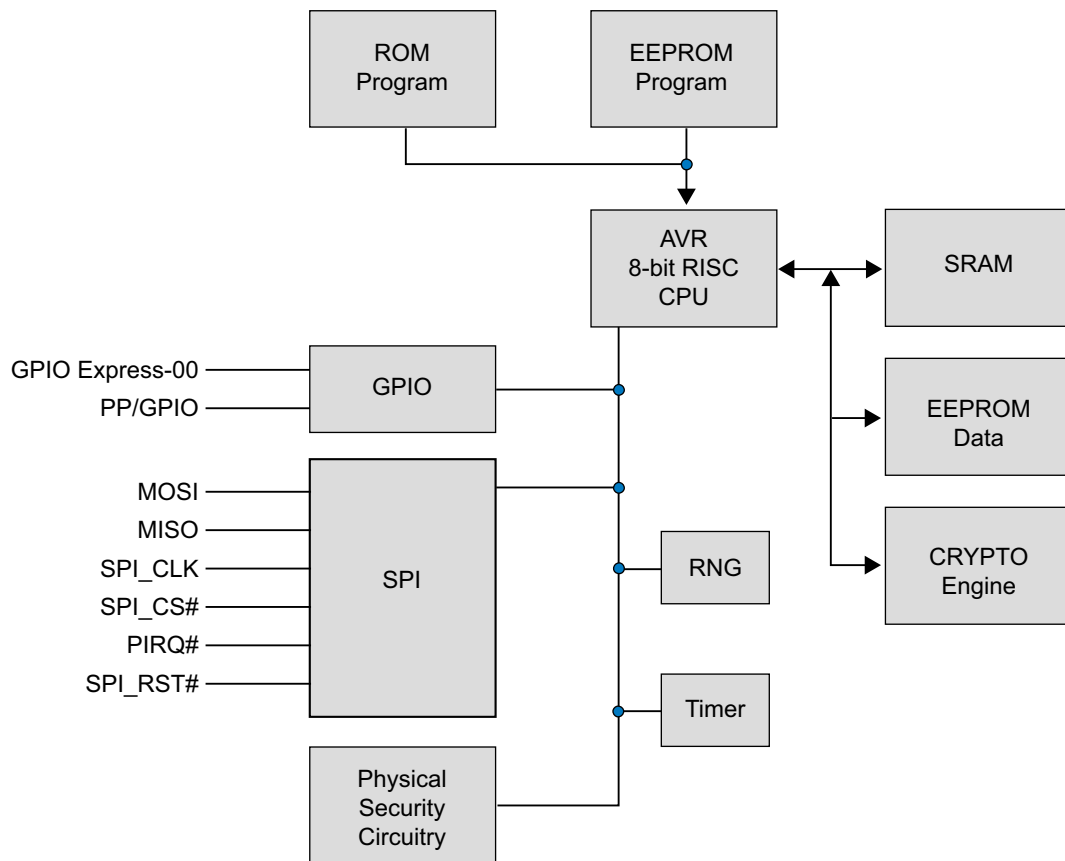

The TPM includes hardware Random Number Generator (RNG), including a FIPS certified Pseudo Random Number Generator that is used for key generation and TCG protocol functions. The RNG is also available to the system to generate random numbers that may be needed during normal operation.

The chip uses a dynamic internal memory management scheme to store multiple RSA keys. Other than the standard TCG commands (TPM_FlushSpecific, TPM_Loadkey2), no system intervention is required to manage this internal key cache.

The TPM is offered to OEM and ODM manufacturers as a turnkey solution, including the firmware integrated on the chip. In addition, Atmel provides the necessary device driver software for integration into certain operating systems, along with BIOS drivers. Atmel will also provide manufacturing support software for use by OEMs and ODMs during initialization and verification of the TPM during board assembly.

Full documentation for TCG primitives can be found in the TCG TPM Main Specification, Parts 1 to 3, on the TCG web site located at <https://www.trustedcomputinggroup.org>. TPM features specific to PC client platforms are specified in the TCG PC Client Specific TPM Interface Specification, version 1.3, also available on the TCG web site. Implementation guidance for PC platforms is outlined in the TCG PC Client Specific Implementation Specification for Conventional Bios, version 1.2, also available on the TCG web site.

3. Pin Description

Table 3-1. Pin Descriptions

Pin	Description
V _{CC}	Power Supply, 3.3V. Care should be taken to prevent excessive noise. Effective decoupling of the V _{CC} inputs to the Atmel TPM is critical to assure consistently reliable operation over the lifetime of the system. The Atmel recommendation is for a decoupling bypass capacitor within the range of 2200pF to 4700pF, to be placed as close as possible, < 5mm, to each of the V _{CC} pins, located between each V _{CC} pin and the immediately adjacent GND pin. A 0.1µF decoupling bypass capacitor should be placed at the node in which these V _{CC} traces join, which should be as close as possible, < 10mm, to the TPM. In all cases, this bypass capacitor should be closer than the next closest component. All capacitors should be of high quality, with dielectric ratings of X5R or X7R. A low-power state is automatically entered when the chip is idle. No further action is required by the system to enter low-power mode.
GND	System Ground.
GPIO Express-00	General Purpose Input/Output. Internal pull-up resistor. This pin is mapped to NV Index TPM_NV_INDEX_GPIO_00. Default TPM configuration: GPIO Input. GPIO-Express-00 also serves as the XOR chain Output during I/O test mode. Since GPIO-Express-00 has an internal pull-up, it should be left floating if unused.
PP/GPIO	General Purpose Input/Output. Internal pull-down resistor. This pin is an indicator for hardware physical presence; active high. Default TPM configuration: GPIO input. Since PP/GPIO has an internal pull-down, it should be left floating if unused.
GPIO	General Purpose Input/Output. If unused, this pin can be tied to GND or V _{CC} at the customers discretion.
MISO	Master In Slave Out. SPI Slave Data Output. This pin serves as the SPI Data output from the TPM.
MOSI	Master Out Slave In. SPI Slave Data Input. This pin serves as the SPI Data Input to the TPM.
PIRQ#	SPI Interrupt Pin, Active-low. This pin is used by the TPM to assert interrupts. If unused, this pin should be tied to ground directly or through a 4.7KΩ resistor.
SPI_CLK	Clock used to drive the SPI bus. This pin should be asserted high for power savings when the TPM is not in use.
SPI_CS#	SPI_CS# Chip Select, Active-low. The TPM chip select.
SPI_RST#	SPI Reset Pin, Active-low. Pulsing this signal low resets the internal state of the TPM, and is equivalent to removal/restoration of power to the chip. The required minimum reset pulse width is 2µs. On power-up, it is critical that reset be kept active-low until V _{CC} , and SPI_CLK stabilize. To be compliant with TCG requirements, this pin needs to be tied to system reset. TPM_Init is indicated by asserting this pin.
TestI	TestI Manufacturing Test Input. Disabled after manufacturing. Tie TestI to ground directly or through a 4.7kΩ resistor.
TestBI/GPIO/ XTamper	TestBI Manufacturing Test Input. The Atmel TPM does not support legacy addressing via the optional BADD implementation of this pin. The TestBI pin also serves as the XTamper pin or an additional GPIO pin, active high. (See the application note, "Atmel Specific TPM Commands Reference Guide" for details on XTamper implementation). If unused, this pin should be tied to ground directly or through a 4.7KΩ resistor.
NC	No Connect Pins (TSSOP). The AT97SC3205 TSSOP package has additional pins which are no connects and can be tied to GND, V _{CC} , or left floating at the customers discretion: <ul style="list-style-type: none"> NC – TSSOP Pin 5 NC – TSSOP Pin 12 NC – TSSOP Pin 13 NC – TSSOP Pin 14 NC – TSSOP Pin 15 NC – TSSOP Pin 27 NC – TSSOP Pin 28

Table 3-1. Pin Descriptions (Continued)

Pin	Description
NC	<p>No Connect Pins (QFN). The AT97SC3205 QFN package has additional pins which are no connects and can be tied to GND, V_{CC}, or left floating at the customers discretion:</p> <ul style="list-style-type: none"> NC – QFN Pin 7 NC – QFN Pin 10 NC – QFN Pin 11 NC – QFN Pin 13 NC – QFN Pin 14 NC – QFN Pin 15 NC – QFN Pin 16 NC – QFN Pin 25 NC – QFN Pin 26 NC – QFN Pin 27 NC – QFN Pin 28 NC – QFN Pin 31

Note: 1. The substrate center pad for the 32-pin QFN is directly tied to GND internally; therefore, this pad can either be left floating or tied to GND.

4. Ordering Information

Atmel Ordering Code	Package		Operating Range
AT97SC3205 ⁽¹⁾	28X1 (28-pin thin TSSOP)	Lead-free, RoHS	Commercial (0°C to 70°C) Industrial (-40°C to 85°C)
	32M3 (32-pin very thin QFN)		

Note: 1. Please see the AT97SC3205 datasheet addendum for the complete catalog number ordering code.

Package Type	
28X1	28-lead, 4.4mm body width, Plastic Thin Shrink Small Outline (thin TSSOP)
32M3	32-pad, 4.0 x 4.0 x 0.9mm body, 0.4mm lead pitch, Very Thin Quad Flat No-Lead (QFN)

5. Package Drawings

5.1 28X1 — 28-lead Thin TSSOP

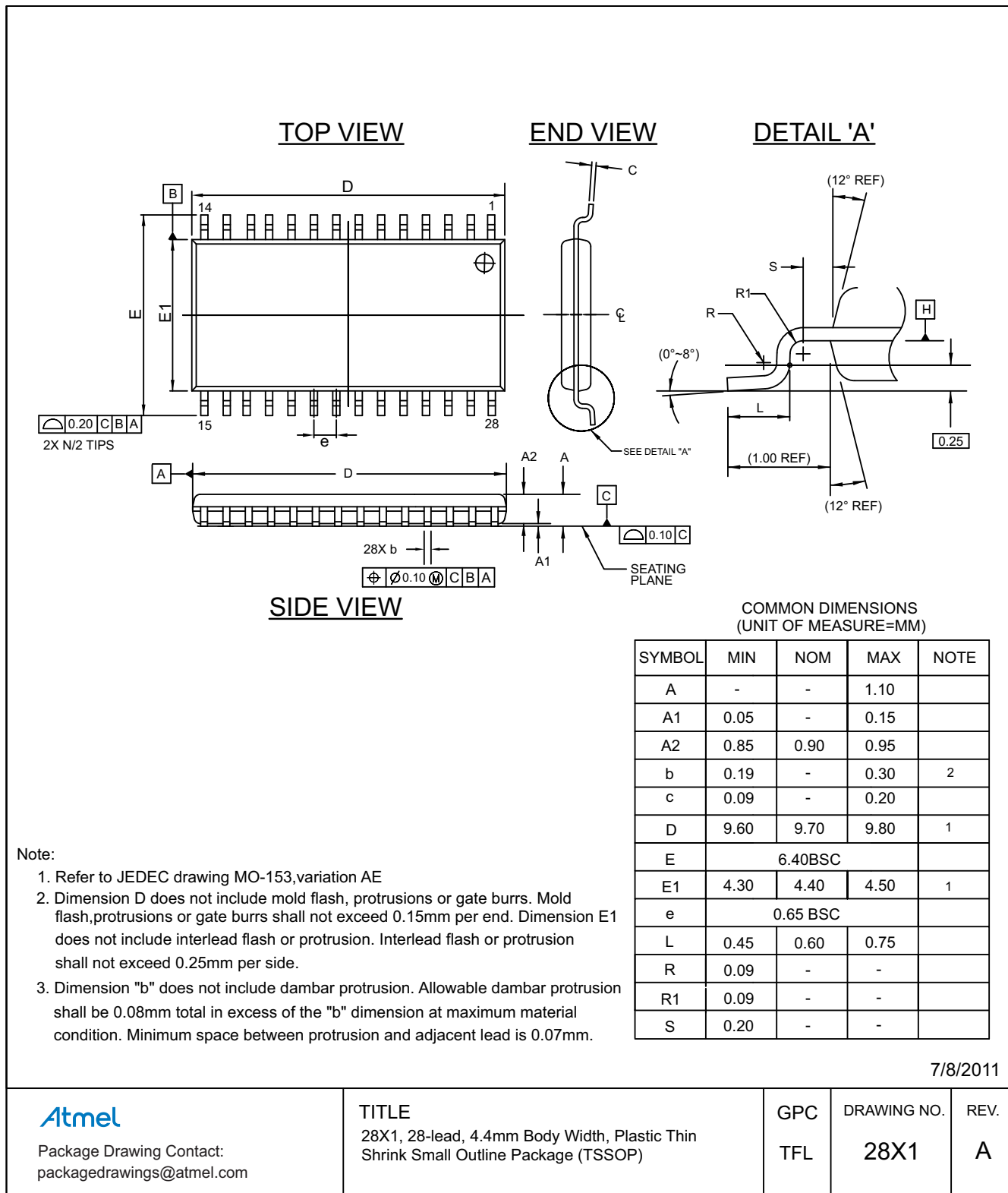

5.2 32M3 — 32-pad QFN

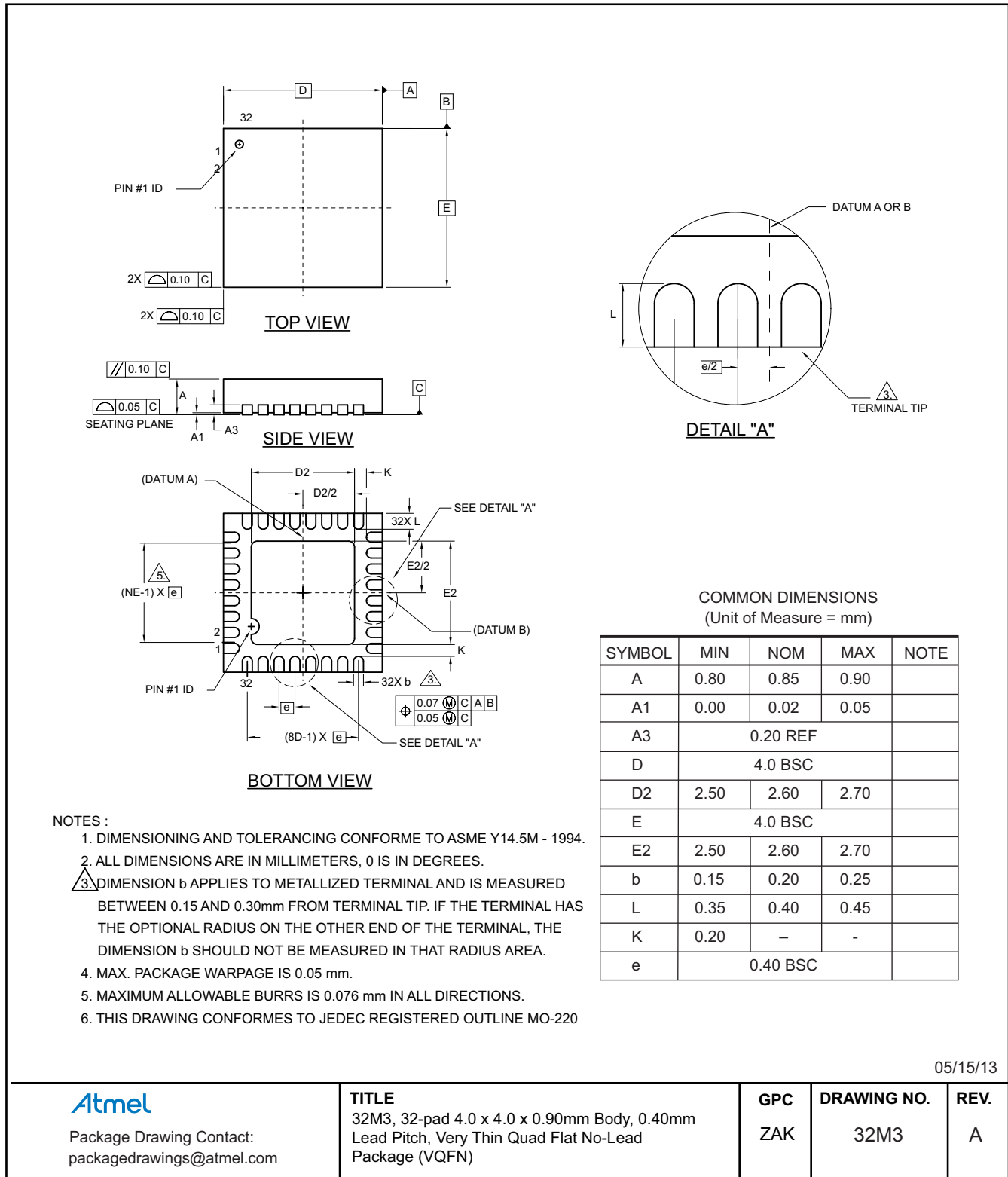

05/15/13

Atmel

Package Drawing Contact:
packagedrawings@atmel.com

TITLE

32M3, 32-pad 4.0 x 4.0 x 0.90mm Body, 0.40mm Lead Pitch, Very Thin Quad Flat No-Lead Package (VQFN)

GPC

ZAK

DRAWING NO.

32M3

REV.

A

6. Revision History

Doc. Rev.	Date	Comments
8884AS	02/2014	Initial summary document release



Atmel®, Atmel logo and combinations thereof, AVR®, and others are registered trademarks or trademarks of Atmel Corporation or its subsidiaries. Other terms and product names may be trademarks of others.

DISCLAIMER: The information in this document is provided in connection with Atmel products. No license, express or implied, by estoppel or otherwise, to any intellectual property right is granted by this document or in connection with the sale of Atmel products. EXCEPT AS SET FORTH IN THE ATMEL TERMS AND CONDITIONS OF SALES LOCATED ON THE ATMEL WEBSITE, ATMEL ASSUMES NO LIABILITY WHATSOEVER AND DISCLAIMS ANY EXPRESS, IMPLIED OR STATUTORY WARRANTY RELATING TO ITS PRODUCTS INCLUDING, BUT NOT LIMITED TO, THE IMPLIED WARRANTY OF MERCHANTABILITY, FITNESS FOR A PARTICULAR PURPOSE, OR NON-INFRINGEMENT. IN NO EVENT SHALL ATMEL BE LIABLE FOR ANY DIRECT, INDIRECT, CONSEQUENTIAL, PUNITIVE, SPECIAL OR INCIDENTAL DAMAGES (INCLUDING, WITHOUT LIMITATION, DAMAGES FOR LOSS AND PROFITS, BUSINESS INTERRUPTION, OR LOSS OF INFORMATION) ARISING OUT OF THE USE OR INABILITY TO USE THIS DOCUMENT, EVEN IF ATMEL HAS BEEN ADVISED OF THE POSSIBILITY OF SUCH DAMAGES. Atmel makes no representations or warranties with respect to the accuracy or completeness of the contents of this document and reserves the right to make changes to specifications and products descriptions at any time without notice. Atmel does not make any commitment to update the information contained herein. Unless specifically provided otherwise, Atmel products are not suitable for, and shall not be used in, automotive applications. Atmel products are not intended, authorized, or warranted for use as components in applications intended to support or sustain life.

SAFETY-CRITICAL, MILITARY, AND AUTOMOTIVE APPLICATIONS DISCLAIMER: Atmel products are not designed for and will not be used in connection with any applications where the failure of such products would reasonably be expected to result in significant personal injury or death ("Safety-Critical Applications") without an Atmel officer's specific written consent. Safety-Critical Applications include, without limitation, life support devices and systems, equipment or systems for the operation of nuclear facilities and weapons systems. Atmel products are not designed nor intended for use in military or aerospace applications or environments unless specifically designated by Atmel as military-grade. Atmel products are not designed nor intended for use in automotive applications unless specifically designated by Atmel as automotive-grade.