



Welcome to E-XFL.COM

Understanding [Embedded - Microcontroller, Microprocessor, FPGA Modules](#)

Embedded - Microcontroller, Microprocessor, and FPGA Modules are fundamental components in modern electronic systems, offering a wide range of functionalities and capabilities. Microcontrollers are compact integrated circuits designed to execute specific control tasks within an embedded system. They typically include a processor, memory, and input/output peripherals on a single chip. Microprocessors, on the other hand, are more powerful processing units used in complex computing tasks, often requiring external memory and peripherals. FPGAs (Field Programmable Gate Arrays) are highly flexible devices that can be configured by the user to perform specific logic functions, making them invaluable in applications requiring customization and adaptability.

Applications of [Embedded - Microcontroller,](#)

Details

Product Status	Obsolete
Module/Board Type	MPU, DSP Core
Core Processor	ARM® Cortex®-A8, DM3730
Co-Processor	TMS320C64x (DSP)
Speed	800MHz
Flash Size	512MB
RAM Size	256MB
Connector Type	Board-to-Board (BTB) Socket - 200
Size / Dimension	0.59" x 1.3" (15mm x 33mm)
Operating Temperature	-40°C ~ 85°C
Purchase URL	https://www.e-xfl.com/product-detail/logic-pd/somdm3730-32-1780akir

PRODUCT BRIEF:

Logic PD :: Texas Instruments
www.logicpd.com/ti

DM3730 / AM3703 Torpedo™ + Wireless System on Module

:: SUPPORTED PROCESSORS:

DM3730
AM3703

Combine a powerful applications processor with PC-like speeds and a wireless chipset with 802.11a/b/g/n, Bluetooth, and GPS support; toss in Android™ and Linux™ BSPs developed using processes compliant with the ISO 13485 medical system standard; and the outcome is an innovative off-the-shelf solution that reduces your development time and risk.

The award-winning Torpedo + Wireless System on Module (SOM) is an ultra-compact form factor built around the Texas Instruments (TI) DaVinci™ DM3730 processor or Sitara™ AM3703 processor and WiLink™ 7.0 wireless solution. Confining these two systems to a single board isolates the complex design, manufacturing, and wireless certifications from the rest of your product.

The DM3730/AM3703 Torpedo + Wireless SOM occupies less than one square inch, but boasts PC-like speeds up to 1 GHz with long battery life. Partnered with such high performance is a startlingly low power consumption in suspend state. This balance of speed and power is accomplished through Logic PD's vast system design experience; understanding the most detailed workings of each component and their interaction with one another creates a product that operates at optimal efficiency.

The WL1283 wireless chipset provides access to all the wireless protocols required in today's connected world.

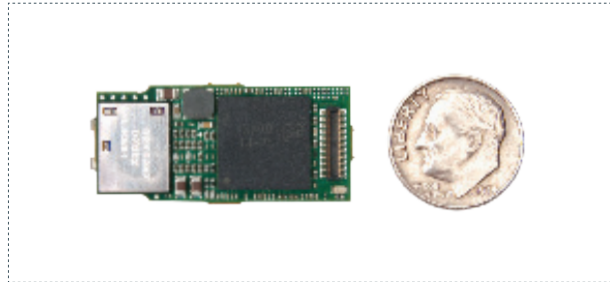

DM3730 / AM3703 TORPEDO + WIRELESS SOM

802.11a/b/g/n, Bluetooth, and GPS signals are natively integrated with the DM3730/AM3703 Torpedo + Wireless SOM and Logic PD BSPs.

By using the same connectors as Logic PD's existing OMAP35x and DM3730/AM3703 Torpedo SOMs, the DM3730/AM3703 Torpedo + Wireless SOM extends the roadmaps of existing products and provides an upgrade path from today's products to future technologies.

The ultra-compact DM3730/AM3703 Torpedo + Wireless SOM is an ideal off-the-shelf solution for applications in markets where network connectivity is required and space is a premium. From point-of-care medical products to handheld communication devices, the DM3730/AM3703 Torpedo + Wireless SOM allows for the powerful versatility and compact designs needed in today's market-changing products.

AWARDS WON IN 2012:

- + CONNECT Most Innovative Product
- + *Design News* Golden Mousetrap Award
- + *Embedded Computing Design* Top Embedded Innovation

DM3730 / AM3703 TORPEDO + WIRELESS SOM :: HIGHLIGHTS:

- + Product-ready System on Module with a TI DM3730 or AM3703 ARM® Cortex™-A8 processor running up to 1 GHz
- + Android™ & Linux™ Board Support Packages (BSPs)
- + Network connectivity: 802.11a/b/g/n, Bluetooth, & GPS
- + FCC & IC modular certified
- + Industrial, commercial, & extended temp configurations
- + Ultra-compact form factor (15 x 33 x 3.8 mm installed)
- + Same connectors as DM3730 / AM3703 Torpedo SOM
- + Long product lifecycle

ZOOM™ DM3730 TORPEDO DEVELOPMENT KIT :: FEATURES:

- + Application baseboard
- + DM3730 Torpedo + Wireless SOM
DM3730 Torpedo SOM
- + 4.3" WQVGA LCD with 4-wire touchscreen
- + Wattson™ power measurement application
- + Necessary accessories to immediately get up and running



DM3730 / AM3703 Torpedo™ + Wireless SOM Block Diagram

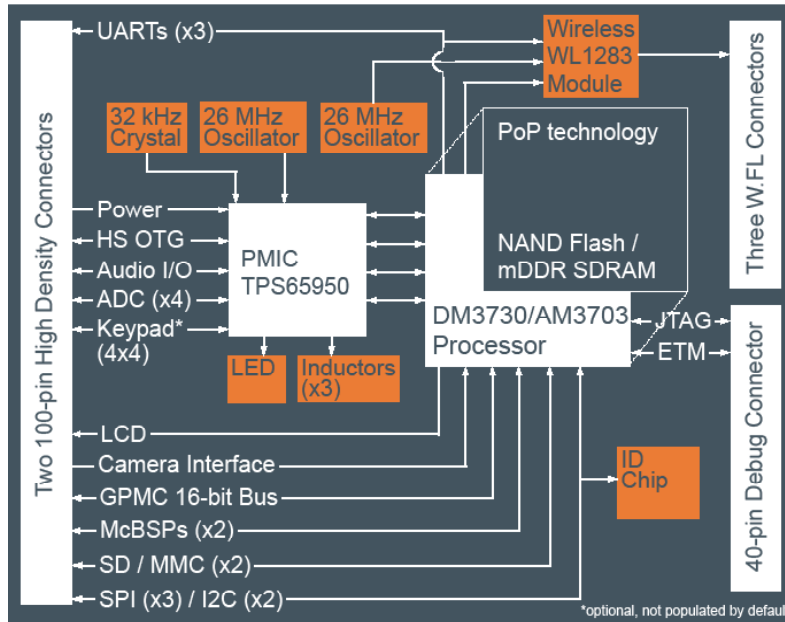

(Block diagram is not drawn to scale; for reference purposes only.)

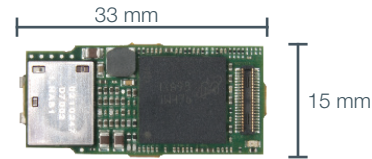

TOP VIEW :: ACTUAL SIZE

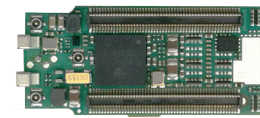

BOTTOM VIEW :: ACTUAL SIZE

DM3730 / AM3703 Torpedo + Wireless SOM Ordering Information

Model Number ¹	Speed (MHz)	SDRAM (MB)	NAND Flash (MB)	Temperature
SOMAM3703-31-1780AKIR	800	256	512	Industrial (-40°C–85°C) ²
SOMDM3730-31-1880AKIR	800	512	512	Industrial (-40°C–85°C) ²
SOMDM3730-31-2780AKCR	1000	256	512	Commercial (0°C–70°C) ³
SOMDM3730-31-2880AKXR	1000	512	512	Extended (-40°C–70°C) ³

NOTES: 1. Custom configurations are available by special order. Please contact Logic PD Sales for details.

2. Junction temperature of the DM3730/AM3703 processor must stay below 105°C.

3. Junction temperature of the DM3730/AM3703 processor must stay below 90°C.

Zoom™ DM3730 Torpedo Development Kit Ordering Information

Model Number	SOM Configuration	Suggested Resale
SDK-DM3730-30-256512R	SOMDM3730-31-2780AKCR SOMDM3730-20-2780AGCR	\$997



411 N. Washington Ave. Suite 400 Minneapolis, MN 55401
 T : 612.672.9495 F : 612.672.9489 I : www.logicpd.com
 © 2016 Logic PD, Inc. All rights reserved. PN: 1020571 Rev K

LOGIC PD WEBSITE :: DESIGN RESOURCES:

+ Logic PD Products : www.logicpd.com/products
 + Logic PD Technical Support : www.logicpd.com/support
 + Logic PD Sales : www.logicpd.com/contact/

Product Features

Processor

- + TI DaVinci™ DM3730 or Sitara™ AM3703 ARM® Cortex™-A8 core running up to 1 GHz
- + TMS320C64x DSP core running up to 800 MHz (DM3730 only)
- + POWER SGX™ graphics accelerator (DM3730 only)

Memory

- + Mobile DDR / NAND flash (PoP technology)
 256 MB / 512 MB (standard)
 512 MB / 512 MB (standard)

Network Connectivity

- + WL1283 wireless module featuring 802.11a/b/g/n, Bluetooth, & GPS

Display

- + Programmable color LCD controller supports up to 24 bpp TFT interface
- + Hardware supports XGA 1024x768 at 24-bit color

Camera

- + Parallel camera interface

Audio

- + I2S-compliant audio codec (16-bit stereo DAC, 13-bit ADC)

User Interface

- + Optional 4x4 keypad interface

PC Card Expansion

- + Multiple SD/MMC card support

USB

- + One USB 2.0 high-speed On-the-Go interface

Serial I/O

- + UARTs, SPI, I2C, McBSPs

GPIO

- + Programmable I/O depending on peripheral requirements
- + General purpose memory controller (GPMC) interface

Debug

- + 40-pin debug connector on top side of SOM
- + JTAG & ETM support

Software

- + Android™ BSP
- + Linux™ BSP
- + LogicLoader™ (bootloader/monitor)
- + Wattson™ power measurement application

Mechanical (Installed)

- + 15 mm wide x 33 mm long x 3.8 mm high

FCC & IC Modular Certified

RoHS Compliant