



Welcome to [E-XFL.COM](https://www.e-xfl.com)

Understanding [Embedded - CPLDs \(Complex Programmable Logic Devices\)](#)

Embedded - CPLDs, or Complex Programmable Logic Devices, are highly versatile digital logic devices used in electronic systems. These programmable components are designed to perform complex logical operations and can be customized for specific applications. Unlike fixed-function ICs, CPLDs offer the flexibility to reprogram their configuration, making them an ideal choice for various embedded systems. They consist of a set of logic gates and programmable interconnects, allowing designers to implement complex logic circuits without needing custom hardware.

Applications of Embedded - CPLDs

Details

Product Status	Active
Programmable Type	In System Programmable
Delay Time tpd(1) Max	5.5 ns
Voltage Supply - Internal	1.7V ~ 1.9V
Number of Logic Elements/Blocks	2
Number of Macrocells	32
Number of Gates	750
Number of I/O	33
Operating Temperature	-40°C ~ 105°C (TA)
Mounting Type	Surface Mount
Package / Case	44-TQFP
Supplier Device Package	44-VQFP (10x10)
Purchase URL	https://www.e-xfl.com/product-detail/xilinx/xa2c32a-7vqg44q

Features

- AEC-Q100 device qualification and full PPAP support available in both I-grade and extended temperature Q-grade
- Guaranteed to meet full electrical specifications over $T_A = -40^{\circ}\text{C}$ to $+105^{\circ}\text{C}$ with T_J Maximum = $+125^{\circ}\text{C}$ (Q-grade)
- Optimized for 1.8V systems
- Industry's best 0.18 micron CMOS CPLD
 - Optimized architecture for effective logic synthesis
 - Multi-voltage I/O operation: 1.5V through 3.3V
- Available in Pb-free 44-pin VQFP with 33 user I/O
- Advanced system features
 - Fastest in system programming
 - 1.8V ISP using IEEE 1532 (JTAG) interface
 - IEEE1149.1 JTAG Boundary Scan Test
 - Optional Schmitt-trigger input (per pin)
 - Two separate I/O banks
 - RealDigital 100% CMOS product term generation
 - Flexible clocking modes
 - Optional DualEDGE triggered registers
 - Global signal options with macrocell control
 - Multiple global clocks with phase selection per macrocell
 - Multiple global output enables
 - Global set/reset
 - Efficient control term clocks, output enables and set/resets for each macrocell and shared across function blocks
 - Advanced design security
 - Open-drain output option for Wired-OR and LED drive
 - Optional configurable grounds on unused I/Os
 - Optional bus-hold, 3-state or weak pullup on selected I/O pins
 - Mixed I/O voltages compatible with 1.5V, 1.8V, 2.5V, and 3.3V logic levels
 - PLA architecture
 - Superior pinout retention
 - 100% product term routability across function block
 - Hot pluggable

Refer to the CoolRunner™-II Automotive CPLD family data sheet for architecture description.

WARNING: Programming temperature range of $T_A = 0^{\circ}\text{C}$ to $+70^{\circ}\text{C}$

Description

The CoolRunner™-II Automotive 32-macrocell device is designed for both high performance and low power applications. This lends power savings to high-end communication equipment and high speed to battery operated devices. Due to the low power stand-by and dynamic operation, overall system reliability is improved

This device consists of two Function Blocks interconnected by a low power Advanced Interconnect Matrix (AIM). The AIM feeds 40 true and complement inputs to each Function Block. The Function Blocks consist of a 40 by 56 P-term PLA and 16 macrocells which contain numerous configuration bits that allow for combinational or registered modes of operation.

Additionally, these registers can be globally reset or preset and configured as a D or T flip-flop or as a D latch. There are also multiple clock signals, both global and local product term types, configured on a per macrocell basis. Output pin configurations include slew rate limit, bus hold, pull-up, open drain and programmable grounds. A Schmitt trigger input is available on a per input pin basis. In addition to storing macrocell output states, the macrocell registers may be configured as "direct input" registers to store signals directly from input pins.

Clocking is available on a global or Function Block basis. Three global clocks are available for all Function Blocks as a synchronous clock source. Macrocell registers can be individually configured to power up to the zero or one state. A global set/reset control line is also available to asynchronously set or reset selected registers during operation. Additional local clock, synchronous clock-enable, asynchronous set/reset and output enable signals can be formed using product terms on a per-macrocell or per-Function Block basis.

The CoolRunner-II Automotive 32-macrocell CPLD is I/O compatible with standard LVTTTL and LVC MOS18, LVC MOS25, and LVC MOS33 (see [Table 1](#)). This device is also 1.5V I/O compatible with the use of Schmitt-trigger inputs.

Another feature that eases voltage translation is I/O banking. Two I/O banks are available on the CoolRunner-II Automotive 32-macrocell device that permit easy interfacing to 3.3V, 2.5V, 1.8V, and 1.5V devices.

RealDigital Design Technology

Xilinx CoolRunner-II Automotive CPLDs are fabricated on a 0.18 micron process technology which is derived from leading edge FPGA product development. CoolRunner-II Automotive CPLDs employ RealDigital, a design technique that makes use of CMOS technology in both the fabrication and design methodology. RealDigital design technology employs a cascade of CMOS gates to implement sum of products instead of traditional sense amplifier methodology. Due to this technology, Xilinx CoolRunner-II Automotive CPLDs achieve both high performance and low power operation.

Supported I/O Standards

The CoolRunner-II Automotive 32-macrocell device features both LVCMOS and LVTTTL I/O implementations. See [Table 1](#) for I/O standard voltages. The LVTTTL I/O standard

is a general purpose EIA/JEDEC standard for 3.3V applications that use an LVTTTL input buffer and Push-Pull output buffer. The LVCMOS standard is used in 3.3V, 2.5V, 1.8V applications. CoolRunner-II Automotive CPLDs are also 1.5V I/O compatible with the use of Schmitt-trigger inputs.

Table 1: I/O Standards for XA2C32A

IOSTANDARD Attribute	Output V _{CCIO}	Input V _{CCIO}
LVTTTL	3.3	3.3
LVCMOS33	3.3	3.3
LVCMOS25	2.5	2.5
LVCMOS18	1.8	1.8
LVCMOS15 ⁽¹⁾	1.5	1.5

(1) LVCMOS15 requires Schmitt-trigger inputs.

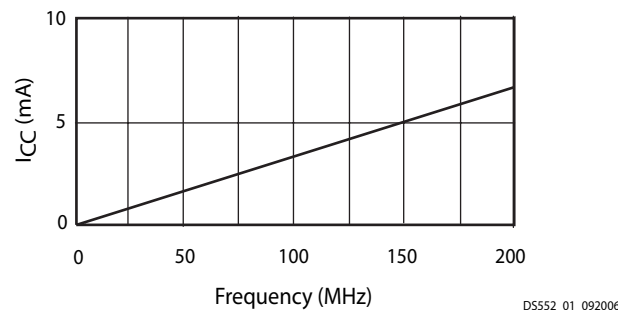

Figure 1: I_{CC} vs Frequency

Table 2: I_{CC} vs Frequency (LVCMOS 1.8V T_A = 25°C)⁽¹⁾

	Frequency (MHz)							
	0	25	50	75	100	150	175	200
Typical I _{CC} (mA)	0.016	0.87	1.75	2.61	3.44	5.16	5.99	6.81

Notes:

- 16-bit up/down, resettable binary counter (one counter per function block).

Absolute Maximum Ratings

Symbol	Description	Value	Units
V_{CC}	Supply voltage relative to ground	-0.5 to 2.0	V
V_{CCIO}	Supply voltage for output drivers	-0.5 to 4.0	V
$V_{JTAG}^{(2)}$	JTAG input voltage limits	-0.5 to 4.0	V
V_{CCAUX}	JTAG input supply voltage	-0.5 to 4.0	V
$V_{IN}^{(1)}$	Input voltage relative to ground	-0.5 to 4.0	V
$V_{TS}^{(1)}$	Voltage applied to 3-state output	-0.5 to 4.0	V
$T_{STG}^{(3)}$	Storage Temperature (ambient)	-65 to +150	°C
T_J	Junction Temperature	+125	°C

Notes:

- Maximum DC undershoot below GND must be limited to either 0.5V or 10 mA, whichever is easiest to achieve. During transitions, the device pins may undershoot to -2.0v or overshoot to +4.5V, provided this over or undershoot lasts less than 10 ns and with the forcing current being limited to 200 mA.
- Valid over commercial temperature range.
- For soldering guidelines and thermal considerations, see the [Device Packaging](#) information on the Xilinx website. For Pb free packages, see [XAPP427](#).

Recommended Operating Conditions

Symbol	Parameter	Min	Max	Units	
V_{CC}	Supply voltage for internal logic and input buffers	Industrial $T_A = -40^{\circ}\text{C}$ to $+85^{\circ}\text{C}$	1.7	1.9	V
		Q-Grade $T_A = -40^{\circ}\text{C}$ to $+105^{\circ}\text{C}$, T_J Maximum = $+125^{\circ}\text{C}$	1.7	1.9	V
V_{CCIO}	Supply voltage for output drivers @ 3.3V operation	3.0	3.6	V	
	Supply voltage for output drivers @ 2.5V operation	2.3	2.7	V	
	Supply voltage for output drivers @ 1.8V operation	1.7	1.9	V	
	Supply voltage for output drivers @ 1.5V operation	1.4	1.6	V	
V_{CCAUX}	JTAG programming pins	1.7	3.6	V	

DC Electrical Characteristics (Over Recommended Operating Conditions)

Symbol	Parameter	Test Conditions	Typical	Max.	Units
I_{CCSB}	Standby current Industrial	$V_{CC} = 1.9\text{V}$, $V_{CCIO} = 3.6\text{V}$	38	150	μA
I_{CCSB}	Standby current Q-grade	$V_{CC} = 1.9\text{V}$, $V_{CCIO} = 3.6\text{V}$	38	550	μA
$I_{CC}^{(1)}$	Dynamic current	$f = 1\text{ MHz}$	-	1.0	mA
		$f = 50\text{ MHz}$	-	4.0	mA
C_{JTAG}	JTAG input capacitance	$f = 1\text{ MHz}$	-	10	pF
C_{CLK}	Global clock input capacitance	$f = 1\text{ MHz}$	-	12	pF
C_{IO}	I/O capacitance	$f = 1\text{ MHz}$	-	10	pF
$I_{IL}^{(2)}$	Input leakage current	$V_{IN} = 0\text{V}$ or V_{CCIO} to 3.9V	-	+/-10	μA
I_{IH}	I/O High-Z leakage	$V_{IN} = 0\text{V}$ or V_{CCIO} to 3.9V	-	+/-10	μA

Notes:

- 16-bit up/down resettable binary counter (one per Function Block) tested at $V_{CC} = V_{CCIO} = 1.9\text{V}$

LVC MOS 3.3V and LV TTL 3.3V DC Voltage Specifications

Symbol	Parameter	Test Conditions	Min.	Max.	Units
V_{CCIO}	Input source voltage		3.0	3.6	V
V_{IH}	High level input voltage		2	3.9	V
V_{IL}	Low level input voltage		-0.3	0.8	V
V_{OH}	High level output voltage, Industrial grade	$I_{OH} = -8 \text{ mA}, V_{CCIO} = 3\text{V}$	$V_{CCIO} - 0.4\text{V}$	-	V
		$I_{OH} = -0.1 \text{ mA}, V_{CCIO} = 3\text{V}$	$V_{CCIO} - 0.2\text{V}$	-	V
	High level output voltage, Q-grade	$I_{OH} = -4 \text{ mA}, V_{CCIO} = 3\text{V}$	$V_{CCIO} - 0.4\text{V}$	-	V
		$I_{OH} = -0.1 \text{ mA}, V_{CCIO} = 3\text{V}$	$V_{CCIO} - 0.2\text{V}$	-	V
V_{OL}	Low level output voltage, Industrial grade	$I_{OL} = 8 \text{ mA}, V_{CCIO} = 3\text{V}$	-	0.4	V
		$I_{OL} = 0.1 \text{ mA}, V_{CCIO} = 3\text{V}$	-	0.2	V
	Low level output voltage, Q-grade	$I_{OL} = 4 \text{ mA}, V_{CCIO} = 3\text{V}$	-	0.4	V
		$I_{OL} = 0.1 \text{ mA}, V_{CCIO} = 3\text{V}$	-	0.2	V

LVC MOS 2.5V DC Voltage Specifications

Symbol	Parameter	Test Conditions	Min.	Max.	Units
V_{CCIO}	Input source voltage		2.3	2.7	V
V_{IH}	High level input voltage		1.7	$V_{CCIO} + 0.3^{(1)}$	V
V_{IL}	Low level input voltage		-0.3	0.7	V
V_{OH}	High level output voltage, Industrial grade	$I_{OH} = -8 \text{ mA}, V_{CCIO} = 2.3\text{V}$	$V_{CCIO} - 0.4\text{V}$	-	V
		$I_{OH} = -0.1 \text{ mA}, V_{CCIO} = 2.3\text{V}$	$V_{CCIO} - 0.2\text{V}$	-	V
	High level output voltage, Q-grade	$I_{OH} = -4 \text{ mA}, V_{CCIO} = 2.3\text{V}$	$V_{CCIO} - 0.4\text{V}$	-	V
		$I_{OH} = -0.1 \text{ mA}, V_{CCIO} = 2.3\text{V}$	$V_{CCIO} - 0.2\text{V}$	-	V
V_{OL}	Low level output voltage, Industrial grade	$I_{OL} = 8 \text{ mA}, V_{CCIO} = 2.3\text{V}$	-	0.4	V
		$I_{OL} = 0.1\text{mA}, V_{CCIO} = 2.3\text{V}$	-	0.2	V
	Low level output voltage, Q-grade	$I_{OL} = 4 \text{ mA}, V_{CCIO} = 2.3\text{V}$	-	0.4	V
		$I_{OL} = 0.1\text{mA}, V_{CCIO} = 2.3\text{V}$	-	0.2	V

- The V_{IH} Max value represents the JEDEC specification for LVC MOS25. The CoolRunner-II input buffer can tolerate up to 3.9V without physical damage.

LVC MOS 1.8V DC Voltage Specifications

Symbol	Parameter	Test Conditions	Min.	Max.	Units
V_{CCIO}	Input source voltage		1.7	1.9	V
V_{IH}	High level input voltage		$0.65 \times V_{CCIO}$	$V_{CCIO} + 0.3^{(1)}$	V
V_{IL}	Low level input voltage		-0.3	$0.35 \times V_{CCIO}$	V
V_{OH}	High level output voltage, Industrial grade	$I_{OH} = -8 \text{ mA}, V_{CCIO} = 1.7\text{V}$	$V_{CCIO} - 0.45$	-	V
		$I_{OH} = -0.1 \text{ mA}, V_{CCIO} = 1.7\text{V}$	$V_{CCIO} - 0.2$	-	V
	High level output voltage, Q-grade	$I_{OH} = -4 \text{ mA}, V_{CCIO} = 1.7\text{V}$	$V_{CCIO} - 0.45$	-	V
		$I_{OH} = -0.1 \text{ mA}, V_{CCIO} = 1.7\text{V}$	$V_{CCIO} - 0.2$	-	V
V_{OL}	Low level output voltage, Industrial grade	$I_{OL} = 8 \text{ mA}, V_{CCIO} = 1.7\text{V}$	-	0.45	V
		$I_{OL} = 0.1 \text{ mA}, V_{CCIO} = 1.7\text{V}$	-	0.2	V
	Low level output voltage, Q-grade	$I_{OL} = 4 \text{ mA}, V_{CCIO} = 1.7\text{V}$	-	0.45	V
		$I_{OL} = 0.1 \text{ mA}, V_{CCIO} = 1.7\text{V}$	-	0.2	V

- The V_{IH} Max value represents the JEDEC specification for LVC MOS18. The CoolRunner-II input buffer can tolerate up to 3.9V without physical damage.

LVC MOS 1.5V DC Voltage Specifications⁽¹⁾

Symbol	Parameter	Test Conditions	Min.	Max.	Units
V_{CCIO}	Input source voltage		1.4	1.6	V
V_{T+}	Input hysteresis threshold voltage		$0.5 \times V_{CCIO}$	$0.8 \times V_{CCIO}$	V
V_{T-}			$0.2 \times V_{CCIO}$	$0.5 \times V_{CCIO}$	V
V_{OH}	High level output voltage, Industrial grade	$I_{OH} = -8 \text{ mA}, V_{CCIO} = 1.4\text{V}$	$V_{CCIO} - 0.45$	-	V
		$I_{OH} = -0.1 \text{ mA}, V_{CCIO} = 1.4\text{V}$	$V_{CCIO} - 0.2$	-	V
	High level output voltage, Q-grade	$I_{OH} = -4 \text{ mA}, V_{CCIO} = 1.4\text{V}$	$V_{CCIO} - 0.45$	-	V
		$I_{OH} = -0.1 \text{ mA}, V_{CCIO} = 1.4\text{V}$	$V_{CCIO} - 0.2$	-	V
V_{OL}	Low level output voltage, Industrial grade	$I_{OL} = 8 \text{ mA}, V_{CCIO} = 1.4\text{V}$	-	0.4	V
		$I_{OL} = 0.1 \text{ mA}, V_{CCIO} = 1.4\text{V}$	-	0.2	V
	Low level output voltage, Q-grade	$I_{OL} = 4 \text{ mA}, V_{CCIO} = 1.4\text{V}$	-	0.4	V
		$I_{OL} = 0.1 \text{ mA}, V_{CCIO} = 1.4\text{V}$	-	0.2	V

Notes:

- Hysteresis used on 1.5V inputs.

Schmitt Trigger Input DC Voltage Specifications

Symbol	Parameter	Test Conditions	Min.	Max.	Units
V_{CCIO}	Input source voltage		1.4	3.9	V
V_{T+}	Input hysteresis threshold voltage		$0.5 \times V_{CCIO}$	$0.8 \times V_{CCIO}$	V
V_{T-}			$0.2 \times V_{CCIO}$	$0.5 \times V_{CCIO}$	V

AC Electrical Characteristics Over Recommended Operating Conditions

Symbol	Parameter	-6		-7		Units
		Min.	Max.	Min.	Max.	
T_{PD1}	Propagation delay single p-term	-	5.5		5.5	ns
T_{PD2}	Propagation delay OR array	-	6.0		6.0	ns
T_{SUD}	Direct input register clock setup time	2.2	-	2.2	-	ns

Symbol	Parameter	-6		-7		Units
		Min.	Max.	Min.	Max.	
T _{SU1}	Setup time fast (single p-term)	2.6	-	2.6	-	ns
T _{SU2}	Setup time (OR array)	3.1	-	3.1	-	ns
T _{HD}	Direct input register hold time	0.0	-	0.0	-	ns
T _H	P-term hold time	0.0	-	0.0	-	ns
T _{CO}	Clock to output	-	4.7	-	4.7	ns
F _{TOGGLE} ⁽¹⁾	Internal toggle rate	-	300	-	300	MHz
F _{SYSTEM1} ⁽²⁾	Maximum system frequency	-	200	-	200	MHz
F _{SYSTEM2} ⁽²⁾	Maximum system frequency	-	182	-	182	MHz
F _{EXT1} ⁽³⁾	Maximum external frequency	-	137	-	137	MHz
F _{EXT2} ⁽³⁾	Maximum external frequency	-	128	-	128	MHz
T _{PSUD}	Direct input register p-term clock setup time	0.9	-	0.9	-	ns
T _{PSU1}	P-term clock setup time (single p-term)	1.3	-	1.3	-	ns
T _{PSU2}	P-term clock setup time (OR array)	1.8	-	1.8	-	ns
T _{PHD}	Direct input register p-term clock hold time	1.6	-	1.6	-	ns
T _{PH}	P-term clock hold	1.2	-	1.2	-	ns
T _{PCO}	P-term clock to output	-	6.0	-	6.0	ns
T _{OE} /T _{OD}	Global OE to output enable/disable	-	5.5	-	6.2	ns
T _{POE} /T _{POD}	P-term OE to output enable/disable	-	6.7	-	8.0	ns
T _{MOE} /T _{MOD}	Macrocell driven OE to output enable/disable	-	6.9	-	7.6	ns
T _{PAO}	P-term set/reset to output valid	-	6.8	-	6.8	ns
T _{AO}	Global set/reset to output valid	-	5.5	-	5.5	ns
T _{SUEC}	Register clock enable setup time	3.0	-	3.0	-	ns
T _{HEC}	Register clock enable hold time	0.0	-	0.0	-	ns
T _{CW}	Global clock pulse width High or Low	2.2	-	2.2	-	ns
T _{PCW}	P-term pulse width High or Low	6.0	-	6.0	-	ns
T _{APRPW}	Asynchronous preset/reset pulse width (High or Low)	6.0	-	6.0	-	ns
T _{CONFIG} ⁽⁴⁾	Configuration time	-	50	-	50	μs

Notes:

1. F_{TOGGLE} is the maximum clock frequency to which a T-Flip Flop can reliably toggle (see the CoolRunner-II Automotive CPLD family data sheet).
2. F_{SYSTEM1} (1/T_{CYCLE}) is the internal operating frequency for a device fully populated with one 16-bit counter through one p-term per macrocell while F_{SYSTEM2} is through the OR array.
3. F_{EXT1} (1/T_{SU1}+T_{CO}) is the maximum external frequency using one p-term while F_{EXT2} is through the OR array.
4. Typical configuration current during T_{CONFIG} is 500 μA.

Internal Timing Parameters

Symbol	Parameter ⁽¹⁾	-6		-7		Units
		Min.	Max.	Min.	Max.	
Buffer Delays						
T _{IN}	Input buffer delay	-	1.7	-	1.7	ns
T _{DIN}	Direct register input delay	-	2.4	-	2.4	ns
T _{GCK}	Global Clock buffer delay	-	2.0	-	2.0	ns
T _{GSR}	Global set/reset buffer delay	-	2.0	-	2.0	ns
T _{GTS}	Global 3-state buffer delay	-	2.1	-	1.5	ns
T _{OUT}	Output buffer delay	-	2.0	-	2.0	ns
T _{EN}	Output buffer enable/disable delay	-	3.4	-	4.7	ns
P-term Delays						
T _{CT}	Control term delay	-	1.6	-	1.6	ns
T _{LOGI1}	Single p-term delay adder	-	1.1	-	1.1	ns
T _{LOGI2}	Multiple p-term delay adder	-	0.5	-	0.5	ns
Macrocell Delay						
T _{PDI}	Input to output valid	-	0.7	-	0.7	ns
T _{LDI}	Setup before clock (transparent latch)	-	2.5	-	2.5	ns
T _{SUI}	Setup before clock	1.8	-	1.8	-	ns
T _{HI}	Hold after clock	0.0	-	0.0	-	ns
T _{ECSU}	Enable clock setup time	1.7	-	1.7	-	ns
T _{ECHO}	Enable clock hold time	0.0	-	0.0	-	ns
T _{COI}	Clock to output valid	-	0.7	-	0.7	ns
T _{AOI}	Set/reset to output valid	-	1.5	-	1.5	ns
Feedback Delays						
T _F	Feedback delay	-	1.4	-	1.4	ns
T _{OEM}	Macrocell to global OE delay	-	0.8	-	0.2	ns
I/O Standard Time Adder Delays 1.5V CMOS						
T _{HYS15}	Hysteresis input adder	-	4.0	-	4.2	ns
T _{OUT15}	Output adder	-	1.0	-	1.0	ns
T _{SLEW15}	Output slew rate adder	-	5.0	-	5.0	ns
I/O Standard Time Adder Delays 1.8V CMOS						
T _{HYS18}	Hysteresis input adder	-	4.0	-	4.0	ns
T _{OUT18}	Output adder	-	0.0	-	0.0	ns
T _{SLEW}	Output slew rate adder	-	5.0	-	5.0	ns

Internal Timing Parameters (Continued)

Symbol	Parameter ⁽¹⁾	-6		-7		Units
		Min.	Max.	Min.	Max.	
I/O Standard Time Adder Delays 2.5V CMOS						
T_{IN25}	Standard input adder	-	0.6	-	0.7	ns
T_{HYS25}	Hysteresis input adder	-	4.0	-	4.0	ns
T_{OUT25}	Output adder	-	0.7	-	0.8	ns
T_{SLEW25}	Output slew rate adder	-	5.0	-	5.5	ns
I/O Standard Time Adder Delays 3.3V CMOS/TTL						
T_{IN33}	Standard input adder	-	0.6	-	0.8	ns
T_{HYS33}	Hysteresis input adder	-	4.0	-	4.0	ns
T_{OUT33}	Output adder	-	1.2	-	1.2	ns
T_{SLEW33}	Output slew rate adder	-	5.0	-	6.6	ns

Notes:

- 1.5 ns input pin signal rise/fall.

Switching Characteristics

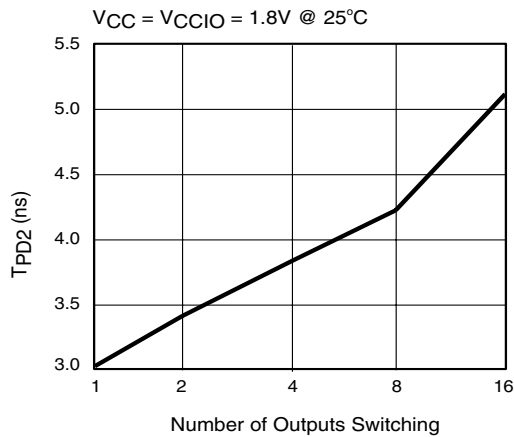
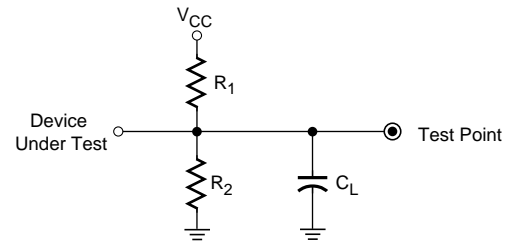

Figure 2: Derating Curve for T_{PD}

DS091_02_112002

AC Test Circuit



Output Type	R_1	R_2	C_L
LVTTL33	268Ω	235Ω	35 pF
LVC MOS33	275Ω	275Ω	35 pF
LVC MOS25	188Ω	188Ω	35 pF
LVC MOS18	112.5Ω	112.5Ω	35 pF
LVC MOS15	150Ω	150Ω	35 pF

C_L includes test fixtures and probe capacitance.
1.5 nsec maximum rise/fall times on inputs.

Figure 3: AC Load Circuit

DS_ACT_08_14_02

Typical I/O Output Curves

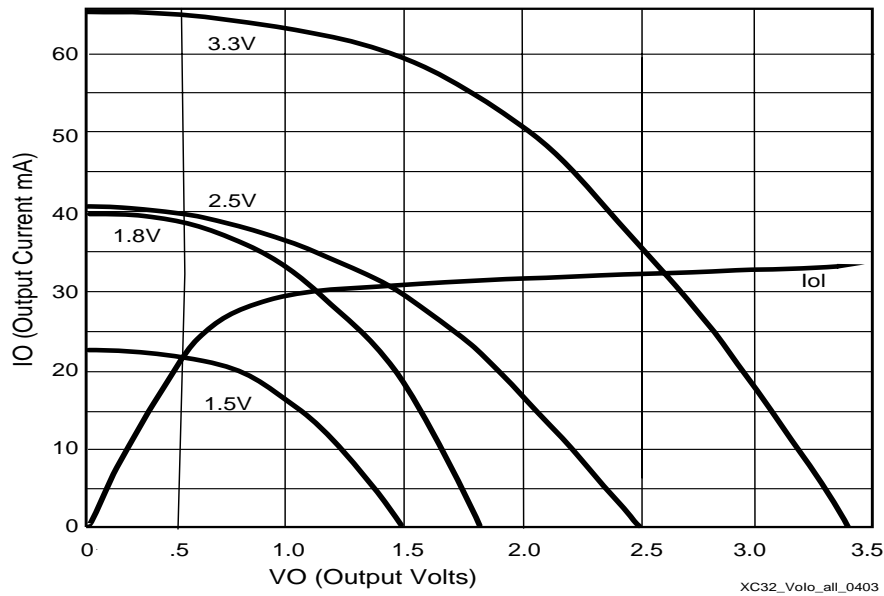

Figure 4: Typical I/V Curve for XA2C32A

Pin Descriptions

Function Block	Macrocell	VQG44	I/O Bank
1	1	38	Bank 2
1	2	37	Bank 2
1	3	36	Bank 2
1(GTS1)	4	34	Bank 2
1(GTS0)	5	33	Bank 2
1(GTS3)	6	32	Bank 2
1(GTS2)	7	31	Bank 2
1(GSR)	8	30	Bank 2
1	9	29	Bank 2
1	10	28	Bank 2
1	11	27	Bank 2
1	12	23	Bank 2
1	13	22	Bank 2
1	14	21	Bank 2
1	15	20	Bank 2
1	16	19	Bank 2
2	1	39	Bank 1
2	2	40	Bank 1
2	3	41	Bank 1
2	4	42	Bank 1
2(GCK0)	5	43	Bank 1
2(GCK1)	6	44	Bank 1
2(GCK2)	7	1	Bank 1

Pin Descriptions (Continued)

Function Block	Macrocell	VQG44	I/O Bank
2	8	2	Bank 1
2	9	3	Bank 1
2	10	5	Bank 1
2	11	6	Bank 1
2	12	8	Bank 1
2	13	12	Bank 1
2	14	13	Bank 1
2	15	14	Bank 1
2	16	16	Bank 1

Notes:

1. GTS = global output enable, GSR = global set reset, GCK = global clock
2. GTS, GSR, and GCK pins can also be used for general purpose I/O.

XA2C32A Global, JTAG, Power/Ground and No Connect Pins

Pin Type	VQG44 ⁽¹⁾
TCK	11
TDI	9
TDO	24
TMS	10
Input Only	18 (bank 2)
V _{CCAUX} (JTAG supply voltage)	35
Power internal (V _{CC})	15
Power bank 1 I/O (V _{CCIO1})	7
Power bank 2 I/O (V _{CCIO2})	26
Ground	4,17,25
No connects	-
Total user I/O (includes dual function pins)	33

Notes:

1. All packages pin compatible with larger macrocell densities

Ordering Information

Part Number	Pin/Ball Spacing	θ_{JA} (C/Watt)	θ_{JC} (C/Watt)	Package Type	Package Body Dimensions	I/O	Ind. (I) ⁽¹⁾ Hi-T(Q)
XA2C32A-6VQG44I	0.8mm	47.7	8.2	Very Thin Quad Flat Pack; Pb-free	10mm x 10mm	33	I
XA2C32A-7VQG44Q							Q

Notes:

1. I = Industrial ($T_A = -40^\circ\text{C}$ to $+85^\circ\text{C}$); Q = Automotive ($T_A = -40^\circ\text{C}$ to $+105^\circ\text{C}$ with T_J Maximum = $+125^\circ\text{C}$)

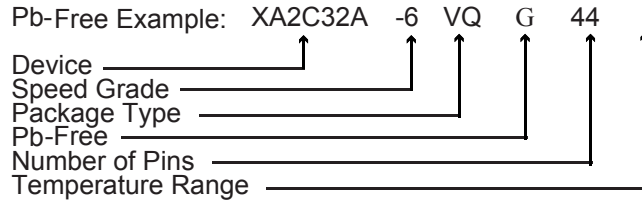

Device Part Marking

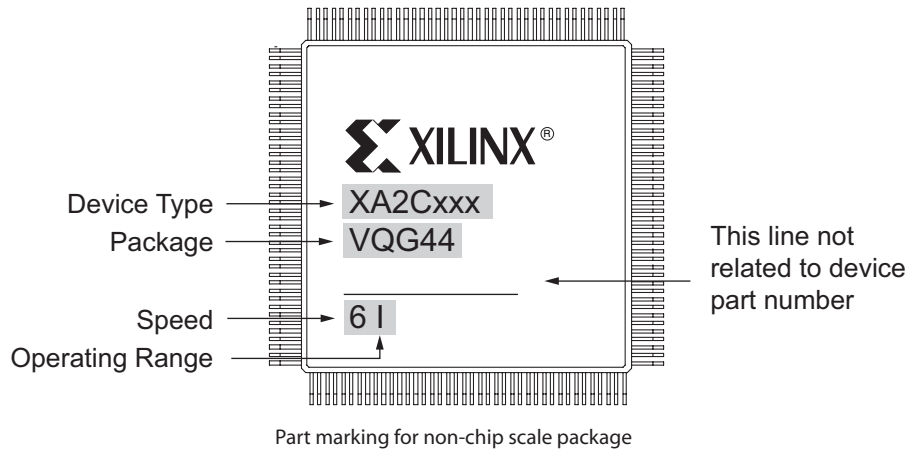
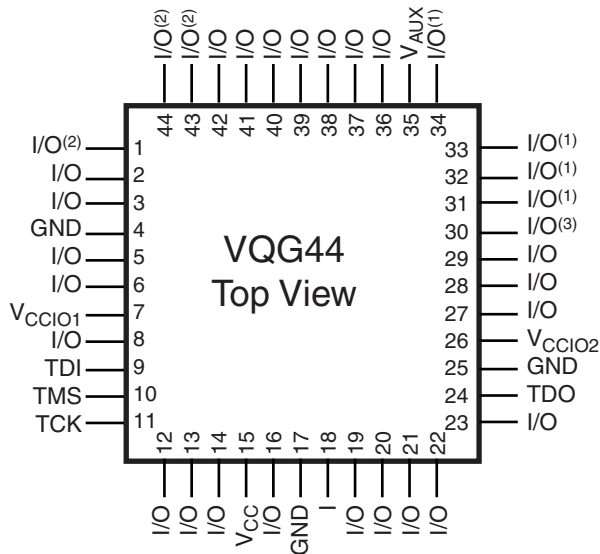

Figure 5: Sample Package with Part Marking



- (1) - Global Output Enable
 (2) - Global Clock
 (3) - Global Set/Reset

Figure 6: VQ44 Package

CoolRunner-II Automotive Requirements and Recommendations

Requirements

The following requirements are for all automotive applications:

- Use a monotonic, fast ramp power supply to power up CoolRunner-II. A V_{CC} ramp time of less than 1 ms is required.
- Do not float I/O pins during device operation. Floating I/O pins can increase I_{CC} as input buffers will draw 1-2 mA per floating input. In addition, when I/O pins are floated, noise can propagate to the center of the CPLD. I/O pins should be appropriately terminated with bus-hold or pull-up. Unused I/Os can also be configured as C_{GND} (programmable GND).
- Do not drive I/O pins without V_{CC}/V_{CCIO} powered.
- Sink current when driving LEDs. Because all Xilinx CPLDs have N-channel pull-down transistors on outputs, it is required that an LED anode is sourced through a resistor externally to V_{CC} . Consequently, this will give the brightest solution.
- Avoid pull-down resistors. Always use external pull-up resistors if external termination is required. This is because the CoolRunner-II Automotive CPLD, which includes some I/O driving circuits beyond the input and output buffers, may have contention with external pull-down resistors, and, consequently, the I/O will not switch as expected.
- Do not drive I/Os pins above the V_{CCIO} assigned to its I/O bank.
 - The current flow can go into V_{CCIO} and affect a user voltage regulator.
 - It can also increase undesired leakage current associated with the device.
 - If done for too long, it can reduce the life of the device.
- Do not rely on the I/O states before the CPLD configures. During power up, the CPLD I/Os may be affected by internal or external signals.
- Use a voltage regulator which can provide sufficient current during device power up. As a rule of thumb, the regulator needs to provide at least three times the peak current while powering up a CPLD in order to guarantee the CPLD can configure successfully.
- Ensure external JTAG terminations for TMS, TCK, TDI, TDO should comply with the IEEE 1149.1. All Xilinx CPLDs have internal weak pull-ups on TDI, TMS, and TCK.

10. Attach all CPLD V_{CC} and GND pins in order to have necessary power and ground supplies around the CPLD.
 11. Decouple all V_{CC} and V_{CCIO} pins with capacitors of 0.01 μF and 0.1 μF closest to the pins for each V_{CC}/V_{CCIO} -GND pair.
 12. Configure I/Os properly. CoolRunner-II Automotive CPLDs have I/O banks; therefore, signals must be assigned to appropriate banks (LVCMOS33, LVCMOS18 ...)
4. Do not disregard report file warnings. Software identifies potential problems when compiling, so the report file is worth inspecting to see exactly how your design is mapped onto the logic.
 5. Understand the Timing Report. This report file provides a speed summary along with warnings. Read the timing file (*.tim) carefully. Analyze key signal chains to determine limits to given clock(s) based on logic analysis.
 6. Review Fitter Report equations. Equations can be shown in ABEL-like format, or can also be displayed in Verilog or VHDL formats. The Fitter Report also includes switch settings that are very informative of other device behaviors.

Recommendations

The following recommendations are for all automotive applications.

1. Use strict synchronous design (only one clocking event) if possible. A synchronous system is more robust than an asynchronous one.
 2. Include JTAG stakes on the PCB. JTAG stakes can be used to test the part on the PCB. They add benefit in reprogramming part on the PCB, inspecting chip internals with INTEST, identifying stuck pins, and inspecting programming patterns (if not secured).
 3. CoolRunner-II Automotive CPLDs work with any power sequence, but it is preferable to power the V_{CCI} (internal V_{CC}) before the V_{CCIO} for the applications in which any glitches from device I/Os are unwanted.
7. Let design software define pinouts if possible. Xilinx CPLD software works best when it selects the I/O pins and manages resources for users. It can spread signals around and improve pin-locking. If users must define pins, plan resources in advance.
 8. Perform a post-fit simulation for all speeds to identify any possible problems (such as race conditions) that might occur when fast-speed silicon is used instead of slow-speed silicon.
 9. Distribute SSOs (Simultaneously Switching Outputs) evenly around the CPLD to reduce switching noise.
 10. Terminate high speed outputs to eliminate noise caused by very fast rising/falling edges.

Automotive Warranty Disclaimer

THIS WARRANTY DOES NOT EXTEND TO ANY IMPLEMENTATION IN AN APPLICATION OR ENVIRONMENT THAT IS NOT CONTAINED WITHIN XILINX SPECIFICATIONS. PRODUCTS ARE NOT DESIGNED TO BE FAIL-SAFE AND ARE NOT WARRANTED FOR USE IN THE DEPLOYMENT OF AIRBAGS. FURTHER, PRODUCTS ARE NOT WARRANTED FOR USE IN APPLICATIONS THAT AFFECT CONTROL OF THE VEHICLE UNLESS THERE IS A FAIL-SAFE OR REDUNDANCY FEATURE AND ALSO A WARNING SIGNAL TO THE OPERATOR OF THE VEHICLE UPON FAILURE. USE OF PRODUCTS IN SUCH APPLICATIONS IS FULLY AT THE RISK OF CUSTOMER SUBJECT TO APPLICABLE LAWS AND REGULATIONS GOVERNING LIMITATIONS ON PRODUCT LIABILITY.

Additional Information

Additional information is available for the following CoolRunner-II topics:

- XAPP784: Bulletproof CPLD Design Practices
- XAPP375: Timing Model
- XAPP376: Logic Engine
- XAPP378: Advanced Features
- XAPP382: I/O Characteristics
- XAPP389: Powering CoolRunner-II
- XAPP399: Assigning VREF Pins

To access these and all application notes with their associated reference designs, click the following link and scroll down the page until you find the document you want:

[CoolRunner-II Data Sheets and Application Notes Device Packages](#)

Revision History

The following table shows the revision history for this document.

Date	Version	Revision
10/31/06	1.0	Initial Xilinx release.
05/05/07	1.1	Change to V_{IH} specification for 3.3V, 2.5V and 1.8V LVCMOS.