

Welcome to [E-XFL.COM](https://www.e-xfl.com)

Understanding [Embedded - CPLDs \(Complex Programmable Logic Devices\)](#)

Embedded - CPLDs, or Complex Programmable Logic Devices, are highly versatile digital logic devices used in electronic systems. These programmable components are designed to perform complex logical operations and can be customized for specific applications. Unlike fixed-function ICs, CPLDs offer the flexibility to reprogram their configuration, making them an ideal choice for various embedded systems. They consist of a set of logic gates and programmable interconnects, allowing designers to implement complex logic circuits without needing custom hardware.

Applications of Embedded - CPLDs

Details

Product Status	Active
Programmable Type	In System Programmable (min 10K program/erase cycles)
Delay Time tpd(1) Max	7.5 ns
Voltage Supply - Internal	4.75V ~ 5.25V
Number of Logic Elements/Blocks	-
Number of Macrocells	64
Number of Gates	-
Number of I/O	64
Operating Temperature	0°C ~ 70°C (TA)
Mounting Type	Surface Mount
Package / Case	100-TQFP
Supplier Device Package	100-TQFP (14x14)
Purchase URL	https://www.e-xfl.com/product-detail/microchip-technology/atf1504as-7ax100

**44-lead TQFP
Top View**

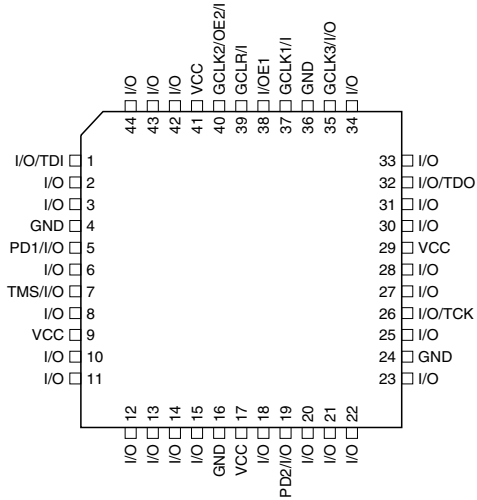

**44-lead PLCC
Top View**

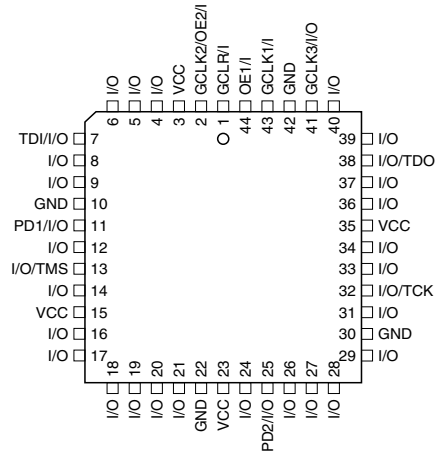

**68-lead PLCC
Top View**

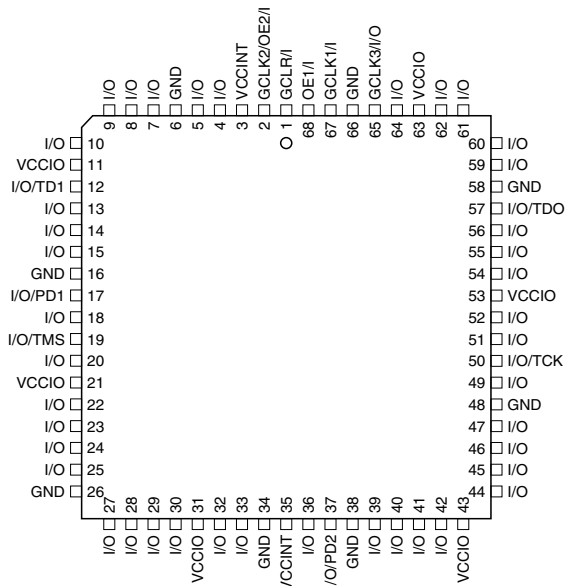

**84-lead PLCC
Top View**

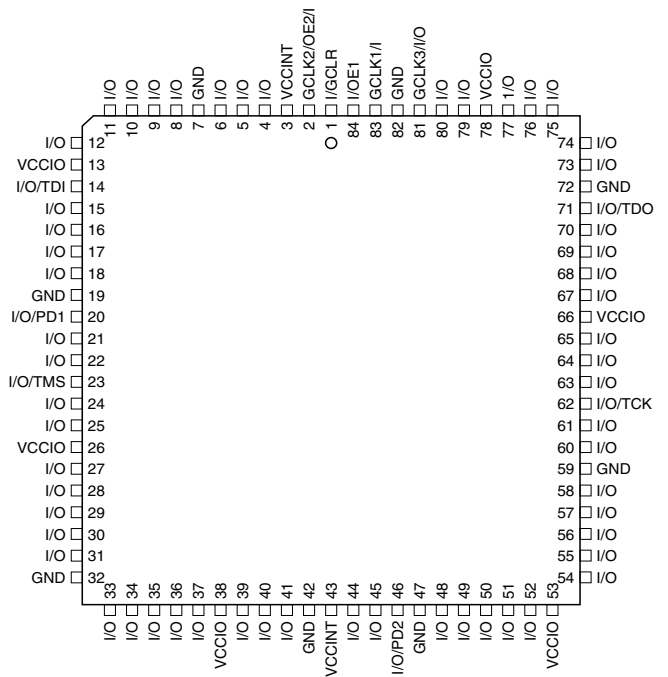

100-lead PQFP Top View

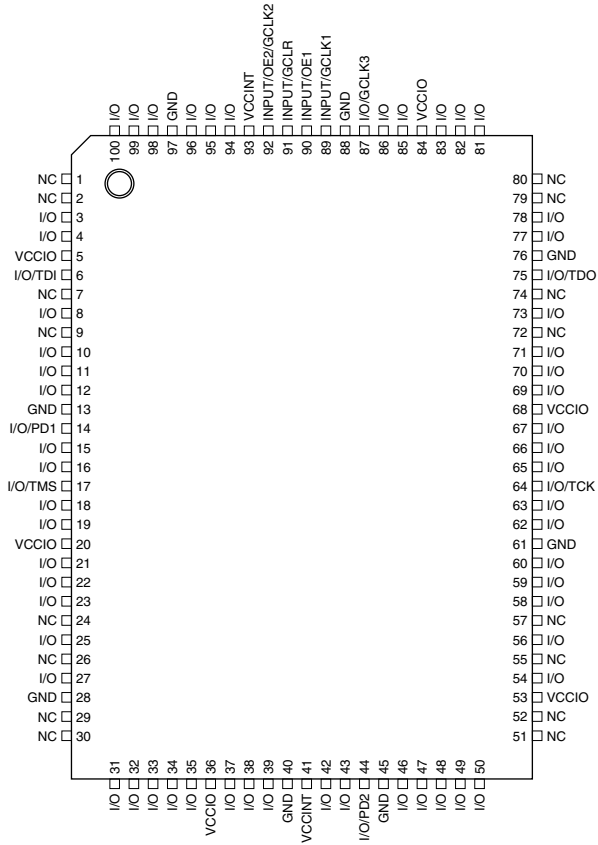

100-lead TQFP Top View

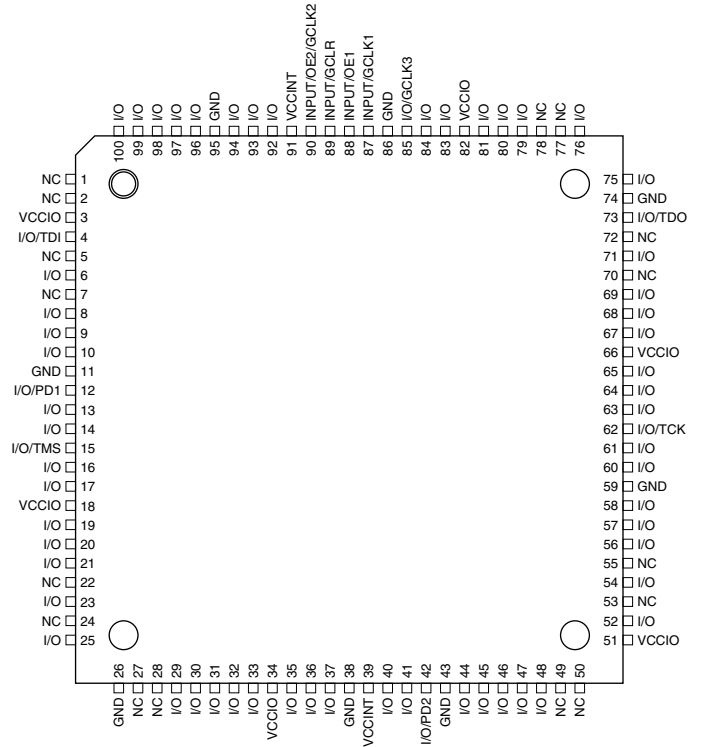

Foldback Bus

Each macrocell also generates a foldback product term. This signal goes to the regional bus and is available to four macrocells. The foldback is an inverse polarity of one of the macrocell's product terms. The sixteen foldback terms in each region allow generation of high fan-in sum terms (up to sixteen product terms) with a nominal additional delay.

Figure 1. ATF1504AS Macrocell

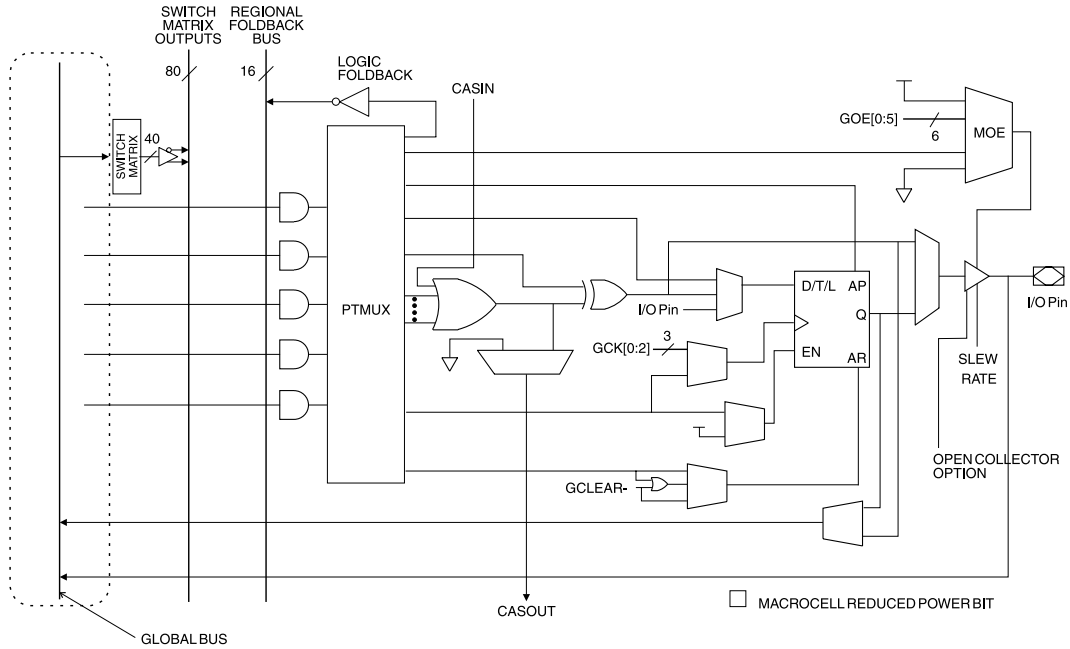



Programming

ATF1504AS devices are in-system programmable (ISP) devices utilizing the 4-pin JTAG protocol. This capability eliminates package handling normally required for programming and facilitates rapid design iterations and field changes.

Atmel provides ISP hardware and software to allow programming of the ATF1504AS via the PC. ISP is performed by using either a download cable or a comparable board tester or a simple microprocessor interface.

To facilitate ISP programming by the Automated Test Equipment (ATE) vendors. Serial Vector Format (SVF) files can be created by Atmel provided software utilities.

ATF1504AS devices can also be programmed using standard third-party programmers. With third-party programmer, the JTAG ISP port can be disabled thereby allowing four additional I/O pins to be used for logic.

Contact your local Atmel representatives or Atmel PLD applications for details.

ISP Programming Protection

The ATF1504AS has a special feature that locks the device and prevents the inputs and I/O from driving if the programming process is interrupted for any reason. The inputs and I/O default to high-Z state during such a condition. In addition the pin-keeper option preserves the former state during device programming, if this circuit were previously programmed on the device. This prevents disturbing the operation of other circuits in the system while the ATF1504AS is being programmed via ISP.

All ATF1504AS devices are initially shipped in the erased state thereby making them ready to use for ISP.

Note: For more information refer to the "Designing for In-System Programmability with Atmel CPLDs" application note.

DC and AC Operating Conditions

	Commercial	Industrial
Operating Temperature (Ambient)	0°C - 70°C	-40°C - 85°C
V _{CCINT} or V _{CCIO} (5V) Power Supply	5V ± 5%	5V ± 10%
V _{CCIO} (3.3V) Power Supply	3.0V - 3.6V	3.0V - 3.6V

DC Characteristics

Symbol	Parameter	Condition	Min	Typ	Max	Units	
I _{IL}	Input or I/O Low Leakage Current	V _{IN} = V _{CC}		-2	-10	μA	
I _{IH}	Input or I/O High Leakage Current			2	10		
I _{OZ}	Tri-state Output Off-state Current	V _O = V _{CC} or GND	-40		40	μA	
I _{CC1}	Power Supply Current, Standby	V _{CC} = Max V _{IN} = 0, V _{CC}	Std Mode	Com.	105		mA
				Ind.	130		mA
			"L" Mode	Com.	10		μA
				Ind.	10		μA
I _{CC2}	Power Supply Current, Power-down Mode	V _{CC} = Max V _{IN} = 0, V _{CC}	"PD" Mode	1	10	mA	
I _{CC3} ⁽²⁾	Current in Reduced-power Mode	V _{CC} = Max V _{IN} = 0, V _{CC}	Std Power	Com	85		ma
				Ind	105		
V _{CCIO}	Supply Voltage	5.0V Device Output	Com.	4.75		5.25	V
			Ind.	4.5		5.5	V
V _{CCIO}	Supply Voltage	3.3V Device Output		3.0		3.6	V
V _{IL}	Input Low Voltage		-0.3		0.8	V	
V _{IH}	Input High Voltage		2.0		V _{CCIO} + 0.3	V	
V _{OL}	Output Low Voltage (TTL)	V _{IN} = V _{IH} or V _{IL} V _{CCIO} = MIN, I _{OL} = 12 mA	Com.			0.45	V
			Ind.				
	Output Low Voltage (CMOS)	V _{IN} = V _{IH} or V _{IL} V _{CC} = MIN, I _{OL} = 0.1 mA	Com.			.2	V
			Ind.			.2	V
V _{OH}	Output High Voltage (TTL)	V _{IN} = V _{IH} or V _{IL} V _{CCIO} = MIN, I _{OH} = -4.0 mA		2.4		V	

- Notes: 1. Not more than one output at a time should be shorted. Duration of short circuit test should not exceed 30 sec.
2. When macrocell reduced-power feature is enabled.

Pin Capacitance

	Typ	Max	Units	Conditions
C _{IN}	8	10	pF	V _{IN} = 0V; f = 1.0 MHz
C _{I/O}	8	10	pF	V _{OUT} = 0V; f = 1.0 MHz

Note: Typical values for nominal supply voltage. This parameter is only sampled and is not 100% tested. The OGI pin (high-voltage pin during programming) has a maximum capacitance of 12 pF.

AC Characteristics (Continued)

Symbol	Parameter	-7		-10		-15		-20		-25		Units
		Min	Max	Min	Max	Min	Max	Min	Max	Min	Max	
f_{MAX}	Maximum Clock Frequency	166.7		125		100		83.3		60		MHz
t_{IN}	Input Pad and Buffer Delay		0.5		0.5		2		2		2	ns
t_{IO}	I/O Input Pad and Buffer Delay		0.5		0.5		2		2		2	ns
t_{FIN}	Fast Input Delay		1		1		2		2		2	ns
t_{SEXP}	Foldback Term Delay		4		5		8		10		12	ns
t_{PEXP}	Cascade Logic Delay		0.8		0.8		1		1		1.2	ns
t_{LAD}	Logic Array Delay		3		5		6		7		8	ns
t_{LAC}	Logic Control Delay		3		5		6		7		8	ns
t_{IOE}	Internal Output Enable Delay		2		2		3		3		4	ns
t_{OD1}	Output Buffer and Pad Delay (Slow slew rate = OFF; $V_{CCIO} = 5V; C_L = 35\text{ pF}$)		2		1.5		4		5		6	ns
t_{OD2}	Output Buffer and Pad Delay (Slow slew rate = OFF; $V_{CCIO} = 3.3V; C_L = 35\text{ pF}$)		2.5		2.0		5		6		7	ns
t_{OD3}	Output Buffer and Pad Delay (Slow slew rate = ON; $V_{CCIO} = 5V\text{ or }3.3V; C_L = 35\text{ pF}$)		5		5.5		8		10		10	ns

Note: See ordering information for valid part numbers.

Timing Model

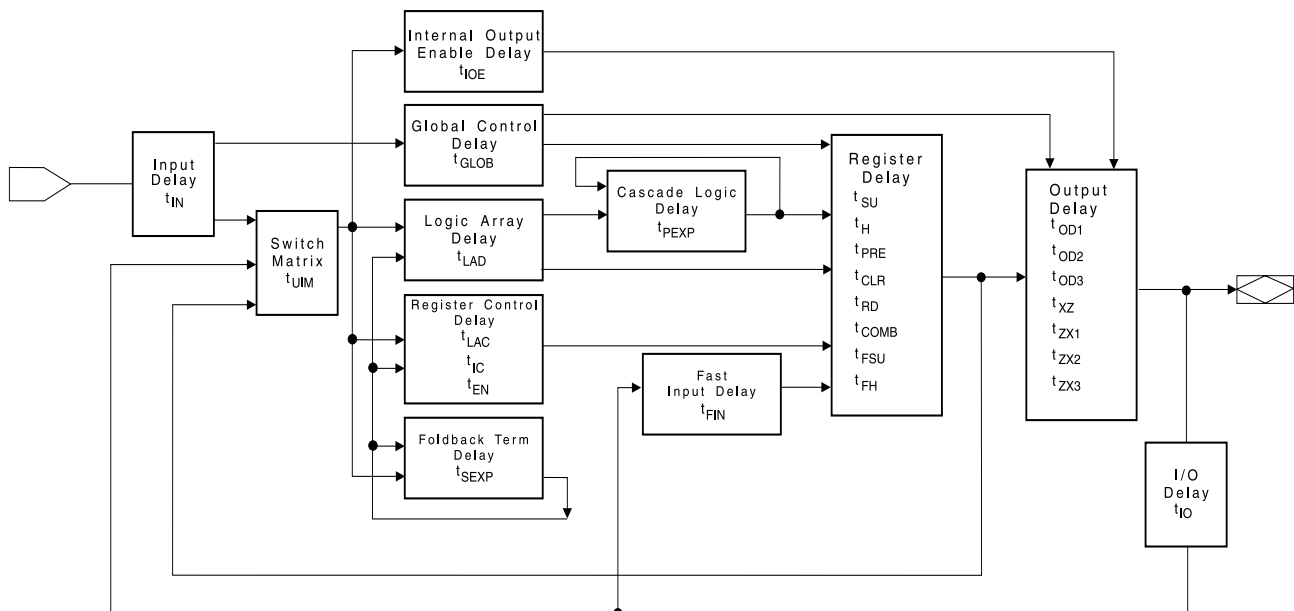

AC Characteristics (Continued)

Symbol	Parameter	-7		-10		-15		-20		-25		Units
		Min	Max	Min	Max	Min	Max	Min	Max	Min	Max	
t_{ZX1}	Output Buffer Enable Delay (Slow slew rate = OFF; $V_{CCIO} = 5.0V$; $C_L = 35$ pF)		4.0		5.0		7		9		10	ns
t_{ZX2}	Output Buffer Enable Delay (Slow slew rate = OFF; $V_{CCIO} = 3.3V$; $C_L = 35$ pF)		4.5		5.5		7		9		10	ns
t_{ZX3}	Output Buffer Enable Delay (Slow slew rate = ON; $V_{CCIO} = 5.0V/3.3V$; $C_L = 35$ pF)		9		9		10		11		12	ns
t_{XZ}	Output Buffer Disable Delay ($C_L = 5$ pF)		4		5		6		7		8	ns
t_{SU}	Register Setup Time	3		3		4		5		6		ns
t_H	Register Hold Time	2		3		4		5		6		ns
t_{FSU}	Register Setup Time of Fast Input	3		3		2		2		3		ns
t_{FH}	Register Hold Time of Fast Input	0.5		0.5		2		2		2.5		ns
t_{RD}	Register Delay		1		2		1		2		2	ns
t_{COMB}	Combinatorial Delay		1		2		1		2		2	ns
t_{IC}	Array Clock Delay		3		5		6		7		8	ns
t_{EN}	Register Enable Time		3		5		6		7		8	ns
t_{GLOB}	Global Control Delay		1		1		1		1		1	ns
t_{PRE}	Register Preset Time		2		3		4		5		6	ns
t_{CLR}	Register Clear Time		2		3		4		5		6	ns
t_{UIM}	Switch Matrix Delay		1		1		2		2		2	ns
t_{RPA}	Reduced-power Adder ⁽²⁾		10		11		13		14		15	ns

- Notes: 1. See ordering information for valid part numbers.
 2. The t_{RPA} parameter must be added to the t_{LAD} , t_{LAC} , t_{TIC} , t_{ACL} , and t_{SEXP} parameters for macrocells running in the reduced-power mode.

Input Test Waveforms and Measurement Levels

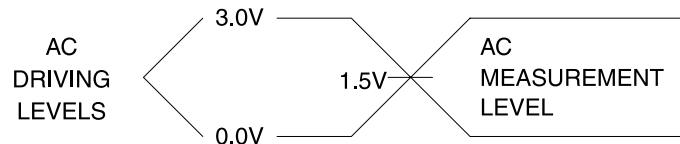

t_R , $t_F = 1.5$ ns typical

Output AC Test Loads

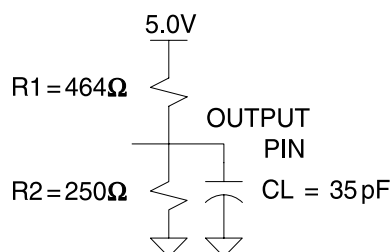

Note: *Numbers in parenthesis refer to 3.0V operating conditions (preliminary).

Power-down Mode

The ATF1504AS includes an optional pin-controlled power-down feature. When this mode is enabled, the PD pin acts as the power-down pin. When the PD pin is high, the device supply current is reduced to less than 10 mA. During power-down, all output data and internal logic states are latched internally and held. Therefore, all registered and combinatorial output data remain valid. Any outputs that were in a high-Z state at the onset will remain at high-Z. During power-down, all input signals except the power-down pin are blocked. Input and I/O hold latches remain active to ensure that pins do not float to indeterminate levels, further reducing system power. The power-down mode feature is enabled in the logic design file or as a fitted or translated s/w option. Designs using the power-down pin may not use the PD pin as a logic array input. However, all other PD pin macrocell resources may still be used, including the buried feedback and foldback product term array inputs.

Power Down AC Characteristics⁽¹⁾⁽²⁾

Symbol	Parameter	-7		-10		-15		-20		-25		Units
		Min	Max	Min	Max	Min	Max	Min	Max	Min	Max	
t_{IVDH}	Valid I, I/O before PD High	7		10		15		20		25		ns
t_{GVDH}	Valid OE ⁽²⁾ before PD High	7		10		15		20		25		ns
t_{CVDH}	Valid Clock ⁽²⁾ before PD High	7		10		15		20		25		ns
t_{DHIX}	I, I/O Don't Care after PD High		12		15		25		30		35	ns
t_{DHGX}	OE ⁽²⁾ Don't Care after PD High		12		15		25		30		35	ns
t_{DHCX}	Clock ⁽²⁾ Don't Care after PD High		12		15		25		30		35	ns
t_{DLIV}	PD Low to Valid I, I/O		1		1		1		1		1	μs
t_{DLGV}	PD Low to Valid OE (Pin or Term)		1		1		1		1		1	μs
t_{DLCV}	PD Low to Valid Clock (Pin or Term)		1		1		1		1		1	μs
t_{DLOV}	PD Low to Valid Output		1		1		1		1		1	μs

- Notes:
1. For slow slew outputs, add t_{SSO} .
 2. Pin or product term.
 3. Includes t_{RPA} due to reduced power bit enabled.

PCI Compliance

The ATF1504AS also supports the growing need in the industry to support the new Peripheral Component Interconnect (PCI) interface standard in PCI-based designs and specifications. The PCI interface calls for high current drivers, which are much larger than the traditional TTL drivers. In general, PLDs and FPGAs parallel outputs to support the high current load required by the PCI interface. The ATF1504AS allows this without contributing to system noise while delivering low output-to-output skew. Having a programmable high drive option is also possible without increasing output delay or pin capacitance. The PCI electrical characteristics appear on the next page.

PCI Voltage-to-current Curves for +5V Signaling in Pull-up Mode

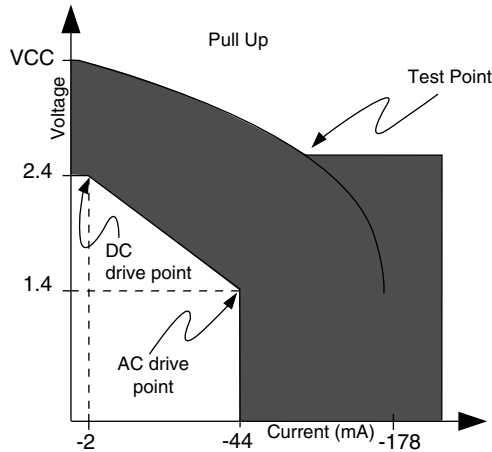

PCI Voltage-to-current Curves for +5V Signaling in Pull-down Mode

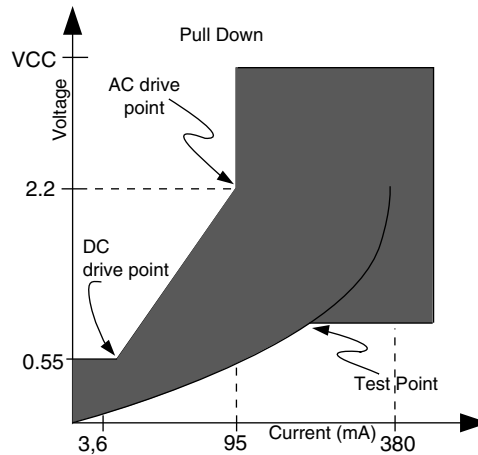

ATF1504AS Dedicated Pinouts

Dedicated Pin	44-lead TQFP	44-lead J-lead	68-lead J-lead	84-lead J-lead	100-lead PQFP	100-lead TQFP
INPUT/OE2/GCLK2	40	2	2	2	92	90
INPUT/GCLR	39	1	1	1	91	89
INPUT/OE1	38	44	68	84	90	88
INPUT/GCLK1	37	43	67	83	89	87
I/O /GCLK3	35	41	65	81	87	85
I/O/PD (1,2)	5, 19	11, 25	17, 37	20, 46	14, 44	12, 42
I/O/TDI (JTAG)	1	7	12	14	6	4
I/O/TMS (JTAG)	7	13	19	23	17	15
I/O/TCK (JTAG)	26	32	50	62	64	62
I/O/TDO (JTAG)	32	38	57	71	75	73
GND	4, 16, 24, 36	10, 22, 30, 42	6, 16, 26, 34, 38, 48, 58, 66	7, 19, 32, 42, 47, 59, 72, 82	13, 28, 40, 45, 61, 76, 88, 97	11, 26, 38, 43, 59, 74, 86, 95
V _{CCINT}	9, 17, 29, 41	3, 15, 23, 35	3, 35	3, 43	41, 93	39, 91
V _{CCIO}	–	–	11, 21, 31, 43, 53, 63	13, 26, 38, 53, 66, 78	5, 20, 36, 53, 68, 84	3, 18, 34, 51, 66, 82
N/C	–	–	–	–	1, 2, 7, 9, 24, 26, 29, 30, 51, 52, 55, 57, 72, 74, 79, 80	1, 2, 5, 7, 22, 24, 27, 28, 49, 50, 53, 55, 70, 72, 77, 78
# of Signal Pins	36	36	52	68	68	68
# User I/O Pins	32	32	48	64	64	64

OE (1, 2) Global OE Pins
GCLR Global Clear Pin
GCLK (1, 2, 3) Global Clock Pins
PD (1, 2) Power down pins
TDI, TMS, TCK, TDO JTAG pins used for boundary-scan testing or in-system programming
GND Ground Pins
V_{CCINT} VCC pins for the device (+5V - Internal)
V_{CCIO} VCC pins for output drivers (for I/O pins) (+5V or 3.3V - I/Os)

ATF1504AS I/O Pinouts

MC	PLC	44-lead PLCC	44-lead TQFP	68-lead PLCC	84-lead PLCC	100-lead PQFP	100-lead TQFP	MC	PLC	44-lead PLCC	44-lead TQFP	68-lead PLCC	84-lead PLCC	100-lead PQFP	100-lead TQFP
1	A	12	6	18	22	16	14	33	C	24	18	36	44	42	40
2	A	–	–	–	21	15	13	34	C	–	–	–	45	43	41
3	A/ PD1	11	5	17	20	14	12	35	C/ PD2	25	19	37	46	44	42
4	A	9	3	15	18	12	10	36	C	26	20	39	48	46	44
5	A	8	2	14	17	11	9	37	C	27	21	40	49	47	45
6	A	–	–	13	16	10	8	38	C	–	–	41	50	48	46
7	A	–	–	–	15	8	6	39	C	–	–	–	51	49	47
8/ TDI	A	7	1	12	14	6	4	40	C	28	22	42	52	50	48
9	A	–	–	10	12	4	100	41	C	29	23	44	54	54	52
10	A	–	–	–	11	3	99	42	C	–	–	–	55	56	54
11	A	6	44	9	10	100	98	43	C	–	–	45	56	58	56
12	A	–	–	8	9	99	97	44	C	–	–	46	57	59	57
13	A	–	–	7	8	98	96	45	C	–	–	47	58	60	58
14	A	5	43	5	6	96	94	46	C	31	25	49	60	62	60
15	A	–	–	–	5	95	93	47	C	–	–	–	61	63	61
16	A	4	42	4	4	94	92	48/ TCK	C	32	26	50	62	64	62
17	B	21	15	33	41	39	37	49	D	33	27	51	63	65	63
18	B	–	–	–	40	38	36	50	D	–	–	–	64	66	64
19	B	20	14	32	39	37	35	51	D	34	28	52	65	67	65
20	B	19	13	30	37	35	33	52	D	36	30	54	67	69	67
21	B	18	12	29	36	34	32	53	D	37	31	55	68	70	68
22	B	–	–	28	35	33	31	54	D	–	–	56	69	71	69
23	B	–	–	–	34	32	30	55	D	–	–	–	70	73	71
24	B	17	11	27	33	31	29	56/ TDO	D	38	32	57	71	75	73
25	B	16	10	25	31	27	25	57	D	39	33	59	73	77	75
26	B	–	–	–	30	25	23	58	D	–	–	–	74	78	76
27	B	–	–	24	29	23	21	59	D	–	–	60	75	81	79
28	B	–	–	23	28	22	20	60	D	–	–	61	76	82	80
29	B	–	–	22	27	21	19	61	D	–	–	62	77	83	81
30	B	14	8	20	25	19	17	62	D	40	34	64	79	85	83
31	B	–	–	–	24	18	16	63	D	–	–	–	80	86	84
32/ TMS	B	13	7	19	23	17	15	64	D/ GCLK3	41	35	65	81	87	85

SUPPLY CURRENT VS. SUPPLY VOLTAGE
($T_A = 25^\circ\text{C}$, $F = 0$)

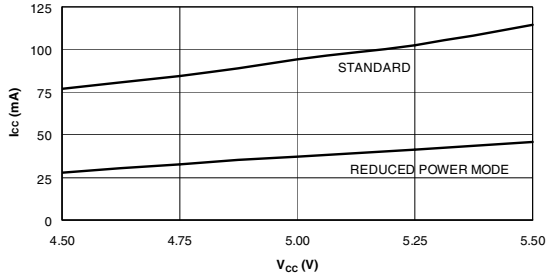

SUPPLY CURRENT VS. SUPPLY VOLTAGE
PIN-CONTROLLED POWER-DOWN MODE
($T_A = 25^\circ\text{C}$, $F = 0$)

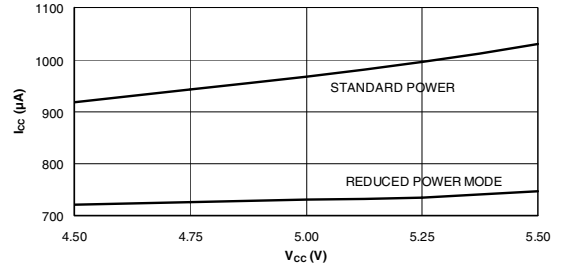

SUPPLY CURRENT VS. SUPPLY VOLTAGE
LOW-POWER ("L") VERSION
($T_A = 25^\circ\text{C}$, $F = 0$)

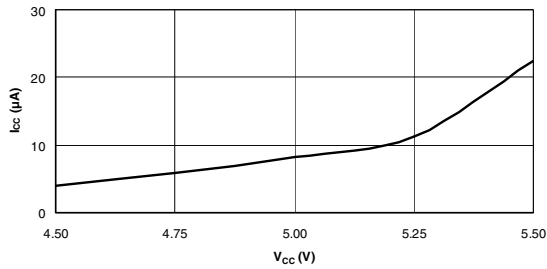

SUPPLY CURRENT VS. FREQUENCY
LOW-POWER ("L") VERSION
LOW POWER ($T_A = 25^\circ\text{C}$)

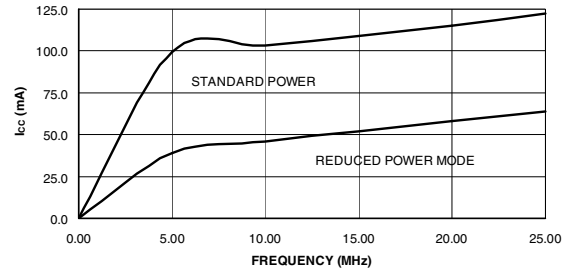

SUPPLY CURRENT VS. FREQUENCY
STANDARD POWER ($T_A = 25^\circ\text{C}$)

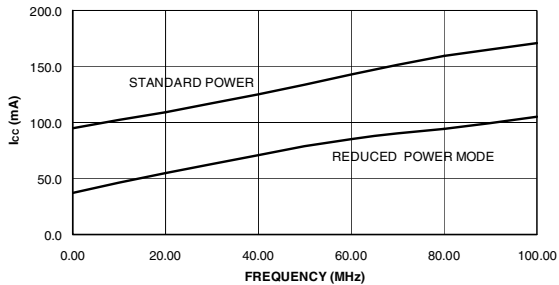

OUTPUT SOURCE CURRENT VS. OUTPUT VOLTAGE
($V_{CC} = 5\text{V}$, $T_A = 25^\circ\text{C}$)

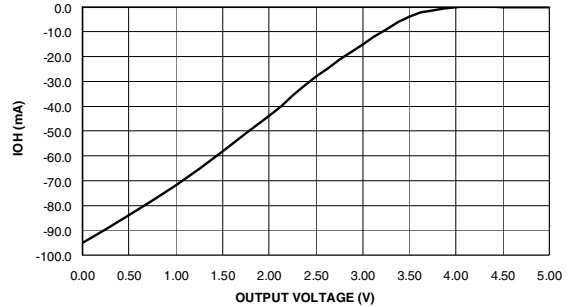

OUTPUT SOURCE CURRENT VS. SUPPLY VOLTAGE
($V_{OH} = 2.4\text{V}$, $T_A = 25^\circ\text{C}$)

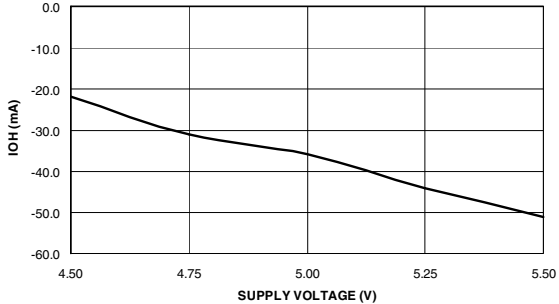

INPUT CLAMP CURRENT VS. INPUT VOLTAGE
($V_{CC} = 5\text{V}$, $T_A = 25^\circ\text{C}$)

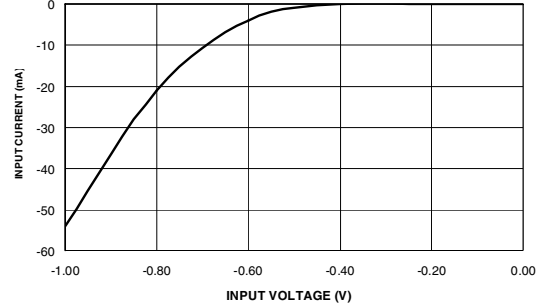

OUTPUT SINK CURRENT VS. SUPPLY VOLTAGE
(VOL = 0.5V, T_A = 25°C)

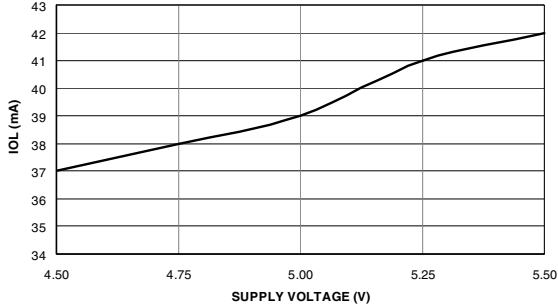

NORMALIZED TPD
VS. TEMPERATURE (V_{CC} = 5.0V)

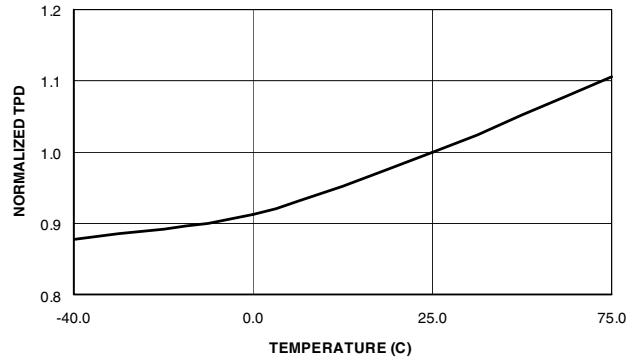

NORMALIZED TPD
VS. SUPPLY VOLTAGE (T_A = 25°C)

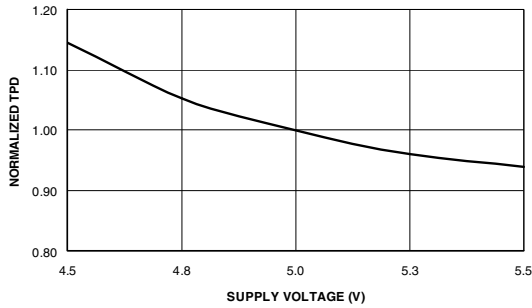

NORMALIZED TCO
VS. SUPPLY VOLTAGE (T_A = 25°C)

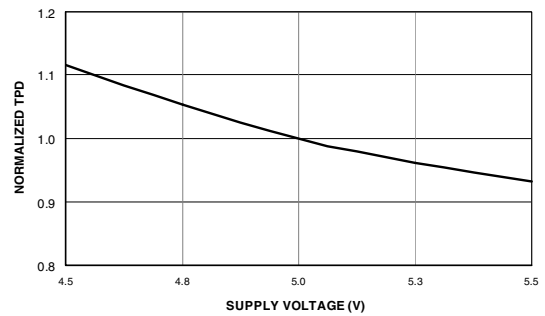

INPUT CURRENT VS. INPUT VOLTAGE
(V_{CC} = 5V, T_A = 25°C)

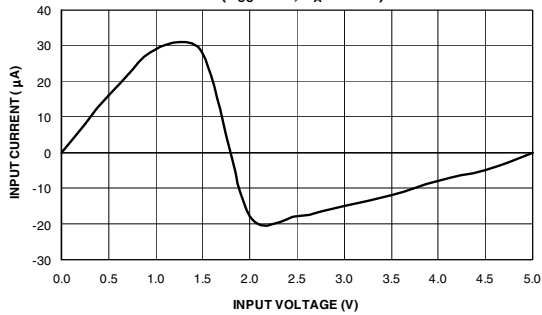

NORMALIZED TSU
VS. SUPPLY VOLTAGE (T_A = 25°C)

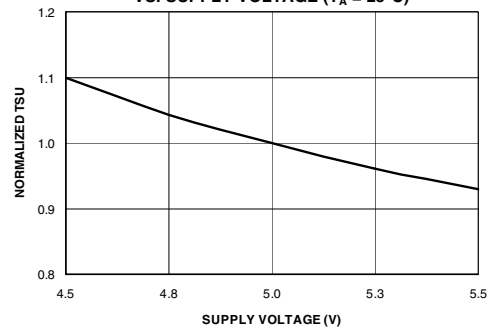

OUTPUT SINK CURRENT VS. OUTPUT VOLTAGE
(V_{CC} = 5V, T_A = 25°C)

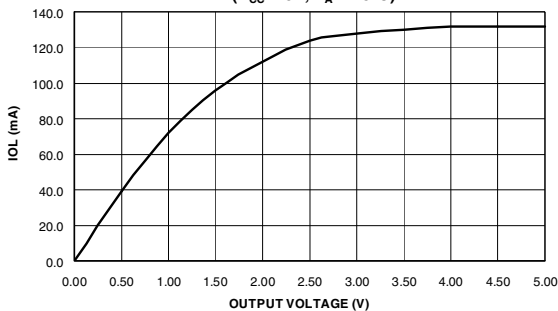

ATF1504AS Ordering Information

t_{PD} (ns)	t_{CO1} (ns)	f_{MAX} (MHz)	Ordering Code	Package	Operation Range
7.5	4.5	166.7	ATF1504AS-7 AC44 ATF1504AS-7 JC44 ATF1504AS-7 JC68 ATF1504AS-7 JC84 ATF1504AS-7 QC100 ATF1504AS-7 AC100	44A 44J 68J 84J 100Q1 100A	Commercial (0°C to 70°C)
10	5	125	ATF1504AS-10 AC44 ATF1504AS-10 JC44 ATF1504AS-10 JC68 ATF1504AS-10 JC84 ATF1504AS-10 QC100 ATF1504AS-10 AC100	44A 44J 68J 84J 100Q1 100A	Commercial (0°C to 70°C)
10	5	125	ATF1504AS-10 AI44 ATF1504AS-10 JI44 ATF1504AS-10 JI68 ATF1504AS-10 JI84 ATF1504AS-10 QI100 ATF1504AS-10 AI100	44A 44J 68J 84J 100Q1 100A	Industrial (-40°C to +85°C)
15	8	100	ATF1504AS-15 AC44 ATF1504AS-15 JC44 ATF1504AS-15 JC68 ATF1504AS-15 JC84 ATF1504AS-15 QC100 ATF1500AS-15 AC100	44A 44J 68J 84J 100Q1 100A	Commercial (0°C to 70°C)
15	8	100	ATF1504AS-15 AI44 ATF1504AS-15 JI44 ATF1504AS-15 JI68 ATF1504AS-15 JI84 ATF1504AS-15 QI100 ATF1504AS-15 AI100	44A 44J 68J 84J 100Q1 100A	Industrial (-40°C to +85°C)

Using “C” Product for Industrial

To use commercial product for Industrial temperature ranges, down-grade one speed grade from the “I” to the “C” device (7 ns “C” = 10 ns “I”) and de-rate power by 30%.

Packaging Information

44A – TQFP

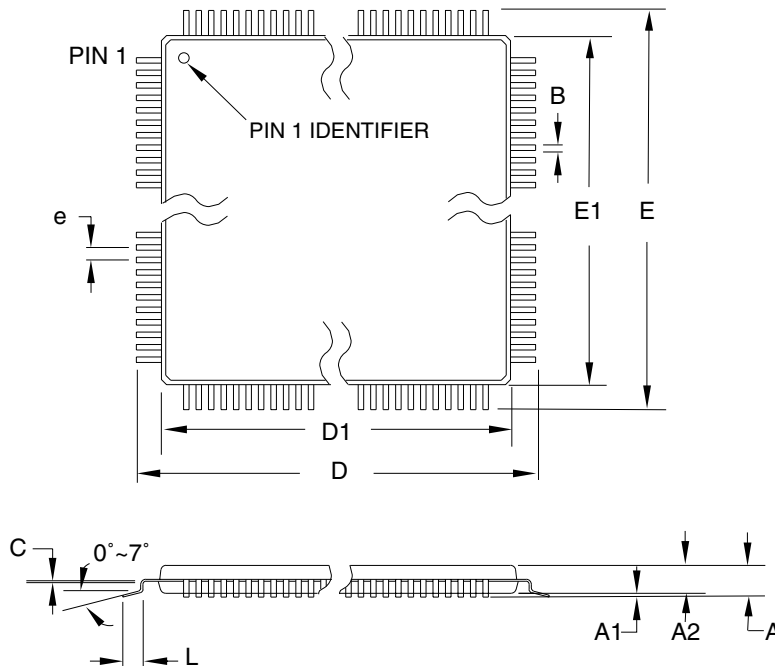

COMMON DIMENSIONS
(Unit of Measure = mm)

SYMBOL	MIN	NOM	MAX	NOTE
A	–	–	1.20	
A1	0.05	–	0.15	
A2	0.95	1.00	1.05	
D	11.75	12.00	12.25	
D1	9.90	10.00	10.10	Note 2
E	11.75	12.00	12.25	
E1	9.90	10.00	10.10	Note 2
B	0.30	–	0.45	
C	0.09	–	0.20	
L	0.45	–	0.75	
e	0.80 TYP			

- Notes:
1. This package conforms to JEDEC reference MS-026, Variation ACB.
 2. Dimensions D1 and E1 do not include mold protrusion. Allowable protrusion is 0.25 mm per side. Dimensions D1 and E1 are maximum plastic body size dimensions including mold mismatch.
 3. Lead coplanarity is 0.10 mm maximum.

10/5/2001



2325 Orchard Parkway
San Jose, CA 95131

TITLE

44A, 44-lead, 10 x 10 mm Body Size, 1.0 mm Body Thickness,
0.8 mm Lead Pitch, Thin Profile Plastic Quad Flat Package (TQFP)

DRAWING NO.

44A

REV.

B



44J – PLCC

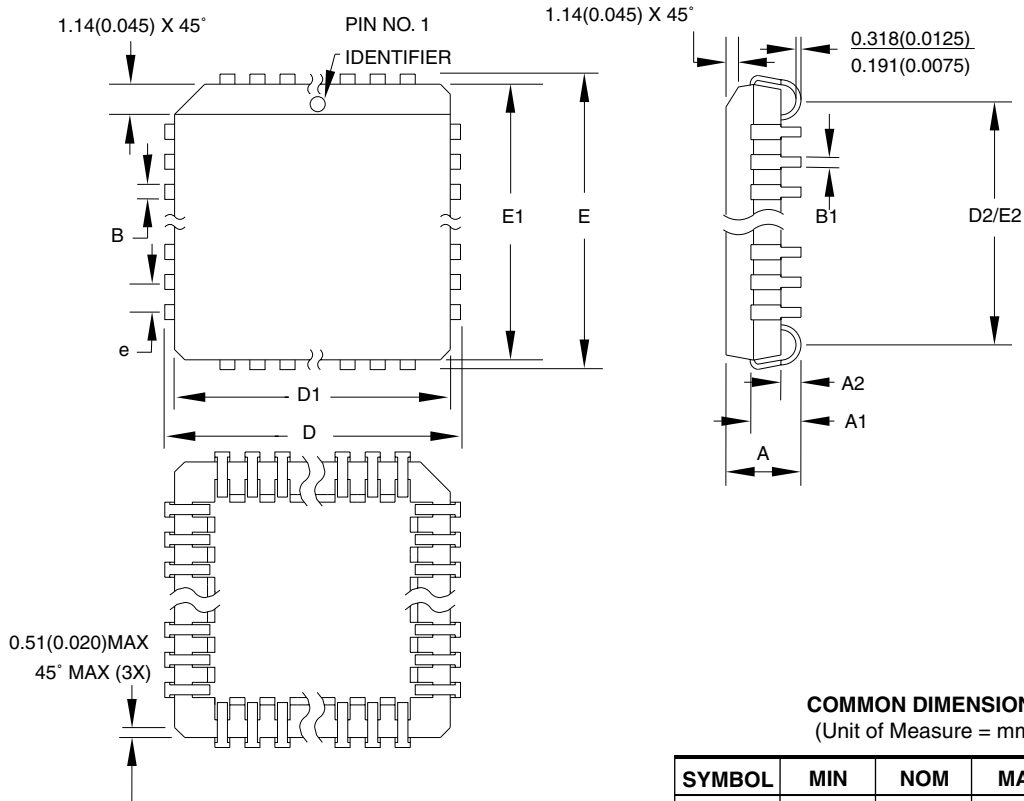

COMMON DIMENSIONS
(Unit of Measure = mm)

SYMBOL	MIN	NOM	MAX	NOTE
A	4.191	–	4.572	
A1	2.286	–	3.048	
A2	0.508	–	–	
D	17.399	–	17.653	
D1	16.510	–	16.662	Note 2
E	17.399	–	17.653	
E1	16.510	–	16.662	Note 2
D2/E2	14.986	–	16.002	
B	0.660	–	0.813	
B1	0.330	–	0.533	
e	1.270 TYP			

- Notes:
1. This package conforms to JEDEC reference MS-018, Variation AC.
 2. Dimensions D1 and E1 do not include mold protrusion. Allowable protrusion is .010" (0.254 mm) per side. Dimension D1 and E1 include mold mismatch and are measured at the extreme material condition at the upper or lower parting line.
 3. Lead coplanarity is 0.004" (0.102 mm) maximum.

10/04/01



2325 Orchard Parkway
San Jose, CA 95131

TITLE

44J, 44-lead, Plastic J-leaded Chip Carrier (PLCC)

DRAWING NO.

44J

REV.

B

68J – PLCC

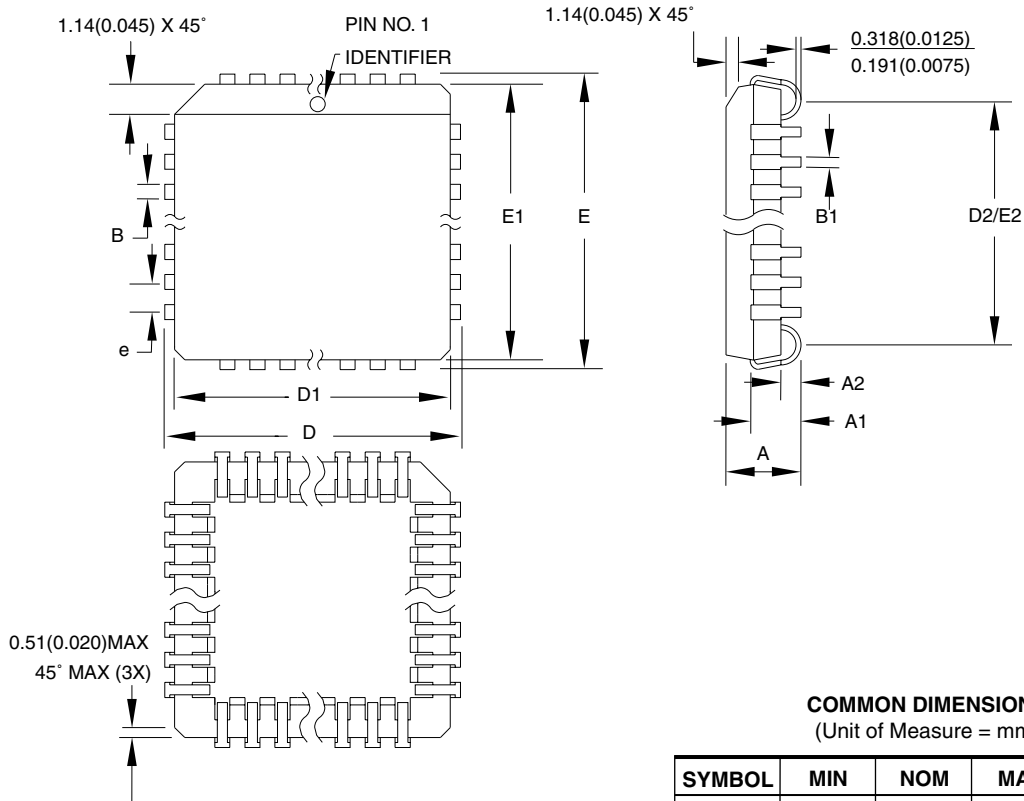

COMMON DIMENSIONS
(Unit of Measure = mm)

SYMBOL	MIN	NOM	MAX	NOTE
A	4.191	–	4.572	
A1	2.286	–	3.048	
A2	0.508	–	–	
D	25.019	–	25.273	
D1	24.130	–	24.333	Note 2
E	25.019	–	25.273	
E1	24.130	–	24.333	Note 2
D2/E2	22.606	–	23.622	
B	0.660	–	0.813	
B1	0.330	–	0.533	
e	1.270 TYP			

- Notes:
1. This package conforms to JEDEC reference MS-018, Variation AE.
 2. Dimensions D1 and E1 do not include mold protrusion. Allowable protrusion is .010"(0.254 mm) per side. Dimension D1 and E1 include mold mismatch and are measured at the extreme material condition at the upper or lower parting line.
 3. Lead coplanarity is 0.004" (0.102 mm) maximum.

10/04/01



2325 Orchard Parkway
San Jose, CA 95131

TITLE

68J, 68-lead, Plastic J-leaded Chip Carrier (PLCC)

DRAWING NO.

68J

REV.

B



84J – PLCC

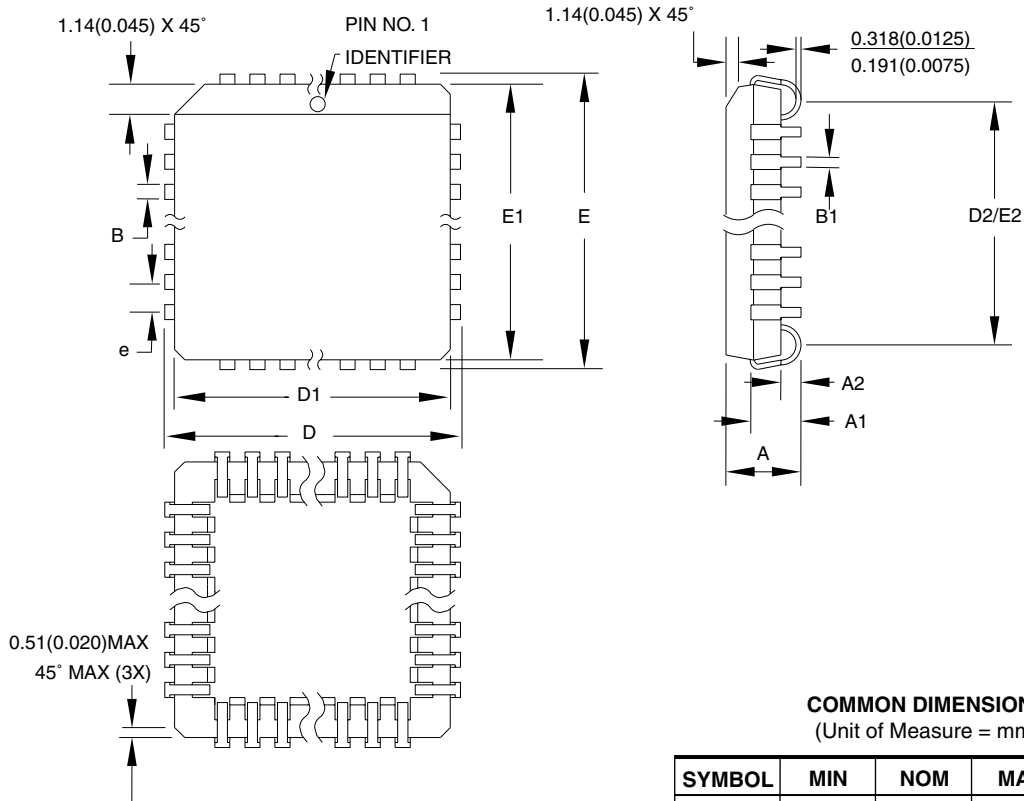

COMMON DIMENSIONS
(Unit of Measure = mm)

SYMBOL	MIN	NOM	MAX	NOTE
A	4.191	–	4.572	
A1	2.286	–	3.048	
A2	0.508	–	–	
D	30.099	–	30.353	
D1	29.210	–	29.413	Note 2
E	30.099	–	30.353	
E1	29.210	–	29.413	Note 2
D2/E2	27.686	–	28.702	
B	0.660	–	0.813	
B1	0.330	–	0.533	
e	1.270 TYP			

- Notes:
1. This package conforms to JEDEC reference MS-018, Variation AF.
 2. Dimensions D1 and E1 do not include mold protrusion. Allowable protrusion is .010" (0.254 mm) per side. Dimension D1 and E1 include mold mismatch and are measured at the extreme material condition at the upper or lower parting line.
 3. Lead coplanarity is 0.004" (0.102 mm) maximum.

10/04/01



2325 Orchard Parkway
San Jose, CA 95131

TITLE

84J, 84-lead, Plastic J-leded Chip Carrier (PLCC)

DRAWING NO.

84J

REV.

B

100A – TQFP

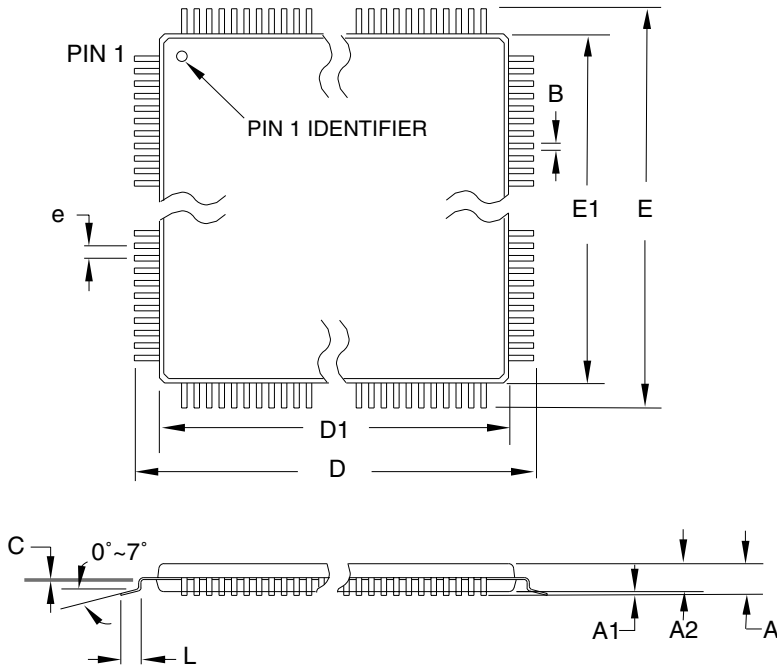

COMMON DIMENSIONS
(Unit of Measure = mm)

SYMBOL	MIN	NOM	MAX	NOTE
A	–	–	1.20	
A1	0.05	–	0.15	
A2	0.95	1.00	1.05	
D	15.75	16.00	16.25	
D1	13.90	14.00	14.10	Note 2
E	15.75	16.00	16.25	
E1	13.90	14.00	14.10	Note 2
B	0.17	–	0.27	
C	0.09	–	0.20	
L	0.45	–	0.75	
e	0.50 TYP			

- Notes:
1. This package conforms to JEDEC reference MS-026, Variation AED.
 2. Dimensions D1 and E1 do not include mold protrusion. Allowable protrusion is 0.25 mm per side. Dimensions D1 and E1 are maximum plastic body size dimensions including mold mismatch.
 3. Lead coplanarity is 0.08 mm maximum.

10/5/2001

2325 Orchard Parkway San Jose, CA 95131	TITLE	DRAWING NO.	REV.
	100A , 100-lead, 14 x 14 mm Body Size, 1.0 mm Body Thickness, 0.5 mm Lead Pitch, Thin Profile Plastic Quad Flat Package (TQFP)	100A	C



Atmel Headquarters

Corporate Headquarters

2325 Orchard Parkway
San Jose, CA 95131
TEL 1(408) 441-0311
FAX 1(408) 487-2600

Europe

Atmel Sarl
Route des Arsenaux 41
Case Postale 80
CH-1705 Fribourg
Switzerland
TEL (41) 26-426-5555
FAX (41) 26-426-5500

Asia

Room 1219
Chinachem Golden Plaza
77 Mody Road Tsimshatsui
East Kowloon
Hong Kong
TEL (852) 2721-9778
FAX (852) 2722-1369

Japan

9F, Tonetsu Shinkawa Bldg.
1-24-8 Shinkawa
Chuo-ku, Tokyo 104-0033
Japan
TEL (81) 3-3523-3551
FAX (81) 3-3523-7581

Atmel Operations

Memory

2325 Orchard Parkway
San Jose, CA 95131
TEL 1(408) 441-0311
FAX 1(408) 436-4314

Microcontrollers

2325 Orchard Parkway
San Jose, CA 95131
TEL 1(408) 441-0311
FAX 1(408) 436-4314

La Chantrerie
BP 70602
44306 Nantes Cedex 3, France
TEL (33) 2-40-18-18-18
FAX (33) 2-40-18-19-60

ASIC/ASSP/Smart Cards

Zone Industrielle
13106 Rousset Cedex, France
TEL (33) 4-42-53-60-00
FAX (33) 4-42-53-60-01

1150 East Cheyenne Mtn. Blvd.
Colorado Springs, CO 80906
TEL 1(719) 576-3300
FAX 1(719) 540-1759

Scottish Enterprise Technology Park
Maxwell Building
East Kilbride G75 0QR, Scotland
TEL (44) 1355-803-000
FAX (44) 1355-242-743

RF/Automotive

Theresienstrasse 2
Postfach 3535
74025 Heilbronn, Germany
TEL (49) 71-31-67-0
FAX (49) 71-31-67-2340

1150 East Cheyenne Mtn. Blvd.
Colorado Springs, CO 80906
TEL 1(719) 576-3300
FAX 1(719) 540-1759

Biometrics/Imaging/Hi-Rel MPU/ High Speed Converters/RF Datacom

Avenue de Rochepleine
BP 123
38521 Saint-Egreve Cedex, France
TEL (33) 4-76-58-30-00
FAX (33) 4-76-58-34-80

e-mail

literature@atmel.com

Web Site

<http://www.atmel.com>

© Atmel Corporation 2002.

Atmel Corporation makes no warranty for the use of its products, other than those expressly contained in the Company's standard warranty which is detailed in Atmel's Terms and Conditions located on the Company's web site. The Company assumes no responsibility for any errors which may appear in this document, reserves the right to change devices or specifications detailed herein at any time without notice, and does not make any commitment to update the information contained herein. No licenses to patents or other intellectual property of Atmel are granted by the Company in connection with the sale of Atmel products, expressly or by implication. Atmel's products are not authorized for use as critical components in life support devices or systems.

ATMEL® is the registered trademark of Atmel.

Other terms and product names may be the trademarks of others.



Printed on recycled paper.