



Welcome to [E-XFL.COM](http://E-XFL.COM)

#### Understanding Embedded - PLDs (Programmable Logic Devices)

Embedded - PLDs, or Programmable Logic Devices, are a type of digital electronic component used to build reconfigurable digital circuits. Unlike fixed-function logic devices, PLDs can be programmed to perform specific functions by the user. This flexibility allows designers to customize the logic to meet the exact needs of their applications, making PLDs a crucial component in modern embedded systems.

#### Applications of Embedded - PLDs (Programmable Logic Devices)

The versatility of PLDs makes them suitable for a wide range of applications. In consumer electronics, PLDs are used to enhance the functionality and performance of

#### Details

Product Status	Obsolete
Programmable Type	EE PLD
Number of Macrocells	8
Voltage - Input	3V ~ 5.5V
Speed	15 ns
Mounting Type	Surface Mount
Package / Case	20-LCC (J-Lead)
Supplier Device Package	20-PLCC (9x9)
Purchase URL	<a href="https://www.e-xfl.com/product-detail/microchip-technology/atf16lv8c-15jc">https://www.e-xfl.com/product-detail/microchip-technology/atf16lv8c-15jc</a>

## Features

- 3.0V to 5.5V Operation
- Industry-standard Architecture
  - Emulates Many 20-pin PALs®
  - Low-cost Easy-to-use Software Tools
- High-speed
  - 10 ns Maximum Pin-to-pin Delay
- Ultra-low Power
  - 5  $\mu$ A (Max) Pin-controlled Power-down Mode Option
  - Typical 100 nA Standby
- CMOS and TTL Compatible Inputs and Outputs
  - I/O Pin-keeper Circuits
- Advanced Flash Technology
  - Reprogrammable
  - 100% Tested
- High-reliability CMOS Process
  - 20 Year Data Retention
  - 100 Erase/Write Cycles
  - 2,000V ESD Protection
  - 200 mA Latchup Immunity
- Commercial and Industrial Temperature Ranges
- Dual-in-line and Surface Mount Packages in Standard Pinouts
- Inputs are 5V Tolerant
- Green Package Options (Pb/Halide-free/RoHS Compliant) Available

## Description

The ATF16LV8C is a high-performance EECMOS programmable logic device that utilizes Atmel's proven electrically-erasable Flash memory technology. Speeds down to 10 ns and a 5  $\mu$ A pin-controlled power-down mode option are offered. All speed  
(continued)

## Pin Configurations

All Pinouts Top View

Pin Name	Function
CLK	Clock
I	Logic Inputs
I/O	Bi-directional Buffers
OE	Output Enable
VCC	(+3V to 5.5V) Supply
PD	Programmable Power-down Option

TSSOP

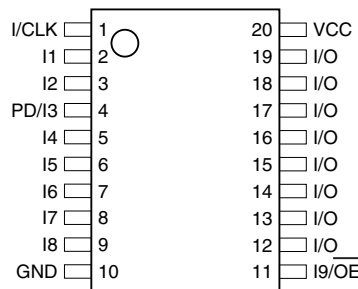

DIP/SOIC

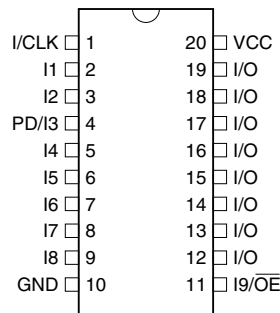

PLCC

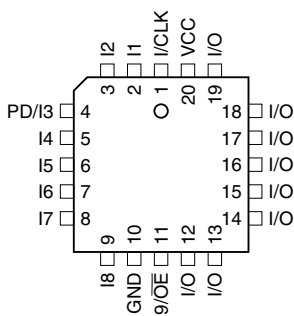

High-performance  
EE PLD

ATF16LV8C



ranges are specified over the full 3.0V to 5.25V range for industrial and commercial temperature ranges.

The ATF16LV8C incorporates a superset of the generic architectures, which allows direct replacement of the 16R8 family and most 20-pin combinatorial PLDs. Eight outputs are each allocated eight product terms. Three different modes of operation, configured automatically with software, allow highly complex logic functions to be realized.

The ATF16LV8C can significantly reduce total system power, thereby enhancing system reliability and reducing power supply costs. When pin 4 is configured as the power-down control pin, supply current drops to less than 5  $\mu$ A whenever the pin is high. If the power-down feature isn't required for a particular application, pin 4 may be used as a logic input. Also, the pin keeper circuits eliminate the need for internal pull-up resistors along with their attendant power consumption.

## Block Diagram

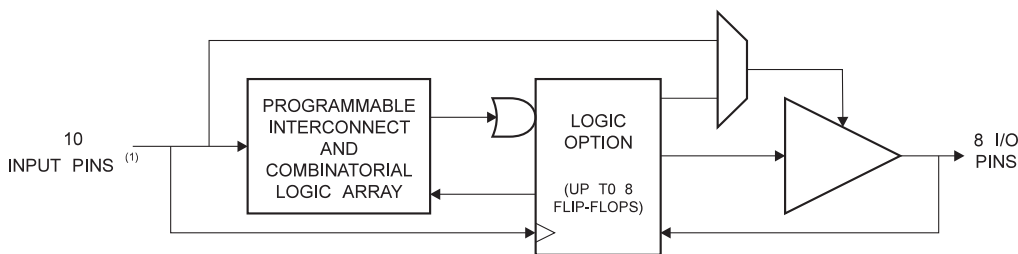

Note: 1. Includes optional PD control pin.

## Absolute Maximum Ratings\*

Temperature Under Bias.....	-40°C to +85°C
Storage Temperature .....	-65°C to +150°C
Voltage on Any Pin with Respect to Ground .....	-2.0V to +7.0V <sup>(1)</sup>
Voltage on Input Pins with Respect to Ground During Programming.....	-2.0V to +14.0V <sup>(1)</sup>
Programming Voltage with Respect to Ground .....	-2.0V to +14.0V <sup>(1)</sup>

\*NOTICE: Stresses beyond those listed under “Absolute Maximum Ratings” may cause permanent damage to the device. This is a stress rating only and functional operation of the device at these or any other conditions beyond those indicated in the operational sections of this specification is not implied. Exposure to absolute maximum rating conditions for extended periods may affect device reliability.

Note: 1. Minimum voltage is -0.6V DC, which may undershoot to -2.0V for pulses of less than 20 ns. Maximum output pin voltage is  $V_{CC} + 0.75V$  DC, which may overshoot to 7.0V for pulses of less than 20 ns.

## DC and AC Operating Conditions

Commercial	
Operating Temperature (Ambient)	0°C - 70°C
$V_{CC}$ Power Supply	3.0V to 5.5V

## DC Characteristics

Symbol	Parameter	Condition <sup>(2)</sup>	Min	Typ	Max	Units
$I_{IL}$	Input or I/O Low Leakage Current	$0 \leq V_{IN} \leq V_{IL}(\text{Max})$			-10	$\mu\text{A}$
$I_{IH}$	Input or I/O High Leakage Current	$1.8 \leq V_{IN} \leq V_{CC}$			10	$\mu\text{A}$
$I_{CC1}^{(1)}$	Power Supply Current	15 MHz, $V_{CC} = \text{Max}$ , $V_{IN} = 0$ , $V_{CC}$ , Outputs Open		Com. Ind.	55 60	mA
$I_{PD}^{(1)}$	Power Supply Current, Power-down Mode	$V_{CC} = \text{Max}$ , $V_{IN} = 0$ , $V_{CC}$		0.1	5	$\mu\text{A}$
$I_{OS}$	Output Short Circuit Current	$V_{OUT} = 0.5\text{V}$ ; $V_{CC} = 3\text{V}$ ; $T_A = 25^\circ\text{C}$			-150	mA
$V_{IL}$	Input Low Voltage	$\text{MIN} < V_{CC} < \text{Max}$	-0.5		0.8	V
$V_{IH}$	Input High Voltage		2.0		$V_{CC} + 1$	V
$V_{OL}$	Output Low Voltage	$V_{CC} = \text{Min}$ ; All Outputs $I_{OL} = 8 \text{ mA}$			0.5	V
$V_{OH}$	Output High Voltage	$V_{CC} = \text{Min}$ $I_{OH} = -4 \text{ mA}$	2.4			V
$I_{OL}$	Output Low Current	$V_{CC} = \text{Min}$	8			mA
$I_{OH}$	Output High Current	$V_{CC} = \text{Min}$	-4			mA

- Note: 1. All  $I_{CC}$  parameters measured with outputs open.  
2. For DC characteristics, the test condition of  $V_{CC} = \text{Max}$  corresponds to 3.6V.

## AC Waveforms<sup>(1)</sup>

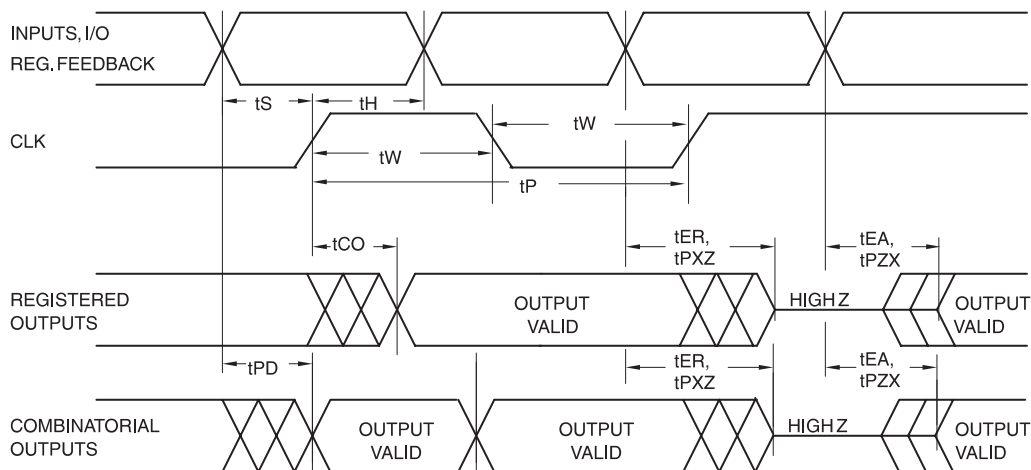

- Note: 1. Timing measurement reference is 1.5V. Input AC driving levels are 0.0V and 3.0V, unless otherwise specified.



## AC Characteristics

Symbol	Parameter	-10		-15		Units
		Min	Max	Min	Max	
$t_{PD}$	Input or Feedback to Non-Registered Output	1	10	1	15	ns
$t_{CF}$	Clock to Feedback		5		8	ns
$t_{CO}$	Clock to Output	2	7	2	10	ns
$t_S$	Input or Feedback Setup Time	7		12		ns
$t_H$	Input Hold Time	0		0		ns
$t_P$	Clock Period	12		16		ns
$t_W$	Clock Width	6		8		ns
$f_{MAX}$	External Feedback $1/(t_S + t_{CO})$		71.4		45.5	MHz
	Internal Feedback $1/(t_S + t_{CF})$		83.3		50	MHz
	No Feedback $1/(t_P)$		83.3		62.5	MHz
$t_{EA}$	Input to Output Enable — Product Term	3	10	3	15	ns
$t_{ER}$	Input to Output Disable — Product Term	2	10	2	15	ns
$t_{PZX}$	$\overline{OE}$ pin to Output Enable	2	8	2	15	ns
$t_{PXZ}$	$\overline{OE}$ pin to Output Disable	1.5	8	1.5	15	ns

## Power-down AC Characteristics<sup>(1)(2)(3)</sup>

Symbol	Parameter	-10		-15		Units
		Min	Max	Min	Max	
$t_{IVDH}$	Valid Input before PD High	10		15		ns
$t_{GVDH}$	Valid $\overline{OE}$ before PD High	0		0		ns
$t_{CVDH}$	Valid Clock before PD High	0		0		ns
$t_{DHIX}$	Input Don't Care after PD High		10		15	ns
$t_{DHGX}$	$\overline{OE}$ Don't Care after PD High		10		15	ns
$t_{DHCX}$	Clock Don't Care after PD High		10		15	ns
$t_{DLIV}$	PD Low to Valid Input		10		15	ns
$t_{DLGV}$	PD Low to Valid $\overline{OE}$		25		30	ns
$t_{DLCV}$	PD Low to Valid Clock		25		30	ns
$t_{DLOV}$	PD Low to Valid Output		30		35	ns

- Notes:
1. Output data is latched and held.
  2. High-Z outputs remain High-Z.
  3. Clock and input transitions are ignored.

## Input Test Waveforms and Measurement Levels:

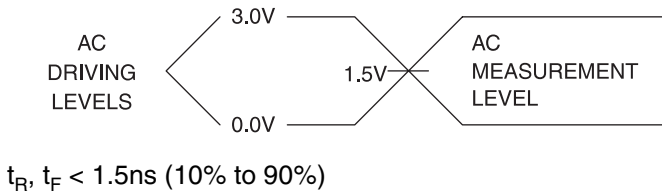

## Output Test Loads: Commercial

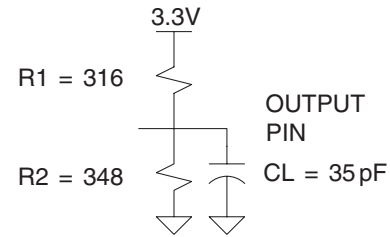

Note: Similar devices are tested with slightly different loads. These load differences may affect output signals' delay and slew rate. Atmel devices are tested with sufficient margins to meet compatible devices.

## Pin Capacitance

( $f = 1\text{MHz}$ ,  $T = 25^\circ\text{C}$ )<sup>(1)</sup>

	Typ	Max	Units	Conditions
$C_{IN}$	5	8	pF	$V_{IN} = 0\text{V}$
$C_{OUT}$	6	8	pF	$V_{OUT} = 0\text{V}$

Note: 1. Typical values for nominal supply voltage. This parameter is only sampled and is not 100% tested.

## Power-up Reset

The ATF16LV8C's registers are designed to reset during power-up. At a point delayed slightly from  $V_{CC}$  crossing  $V_{RST}$ , all registers will be reset to the low state. As a result, the registered output state will always be high on power-up.

This feature is critical for state machine initialization. However, due to the asynchronous nature of reset and the uncertainty of how  $V_{CC}$  actually rises in the system, the following conditions are required:

1. The  $V_{CC}$  rise must be monotonic from below 0.7V.
2. The signals from which the clock is derived must remain stable during  $T_{PR}$ .
3. After  $T_{PR}$ , all input and feedback setup times must be met before driving the clock term high.

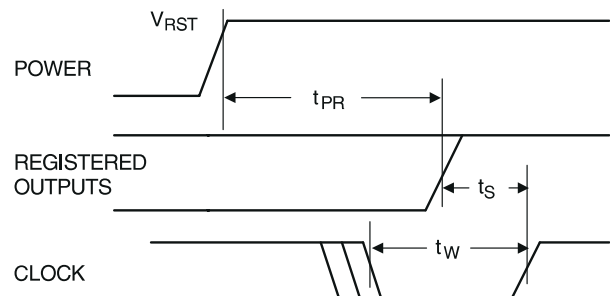

Parameter	Description	Typ	Max	Units
$T_{PR}$	Power-up Reset Time	600	1,000	ns
$V_{RST}$	Power-up Reset Voltage	2.5	3.0	V

**SUPPLY CURRENT  
VS. INPUT FREQUENCY**  
(VCC = 3.3V, TA = 25°C)

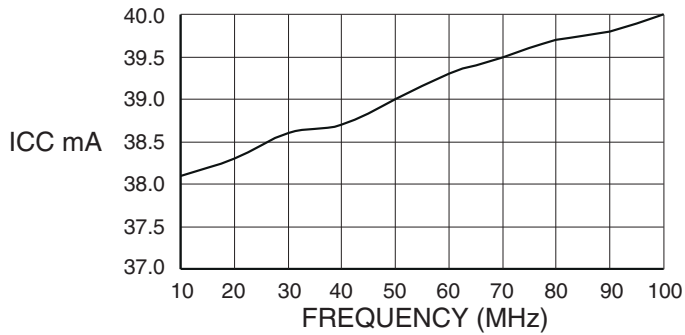

**OUTPUT SINK CURRENT  
VS. OUTPUT VOLTAGE (VCC = 5V, TA = 25°C)**

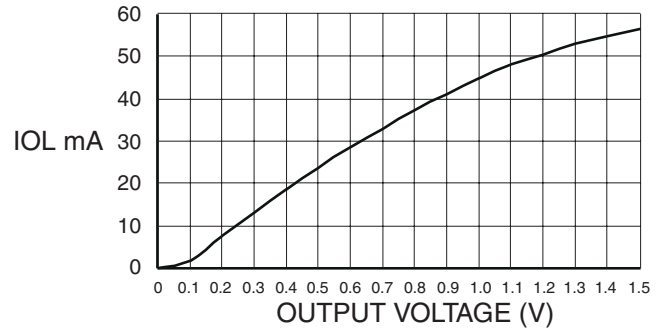

**NORMALIZED SUPPLY CURRENT  
VS. AMBIENT TEMPERATURE**  
(VCC = 3.3V, STANDBY)

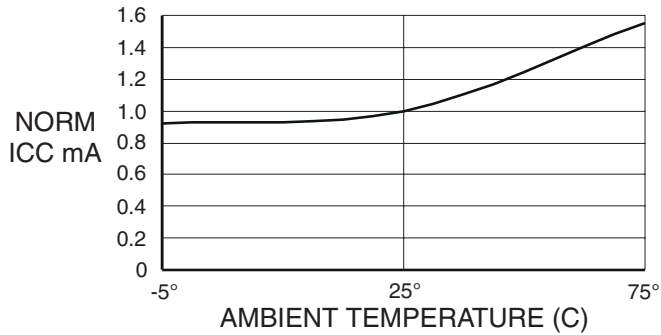

**NORMALIZED SUPPLY CURRENT  
VS. SUPPLY VOLTAGE**  
(TA = 25°C, STANDBY)

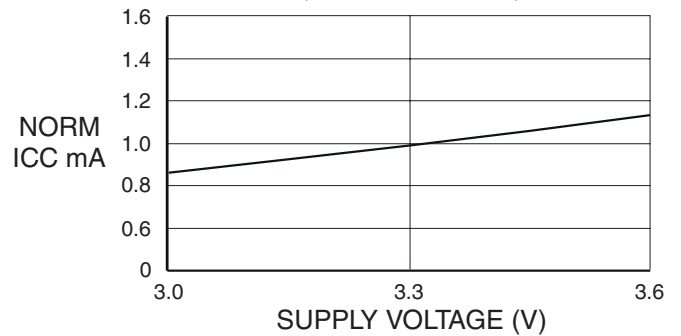

**OUTPUT SINK CURRENT  
VS. SUPPLY VOLTAGE (TA = 25°C, VOL = 0.45V)**

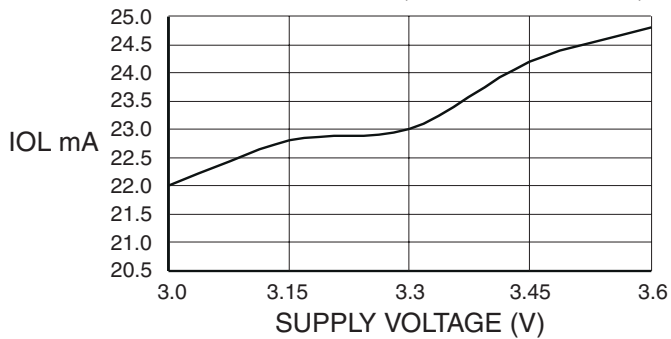

**OUTPUT SOURCE CURRENT  
VS. SUPPLY VOLTAGE (VOH = 2.4V, TA = 25°C)**

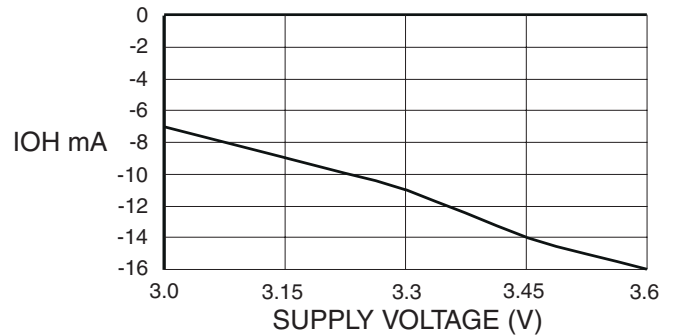

OUTPUT SOURCE CURRENT  
VS. OUTPUT VOLTAGE (VCC = 5V, TA = 25°C)

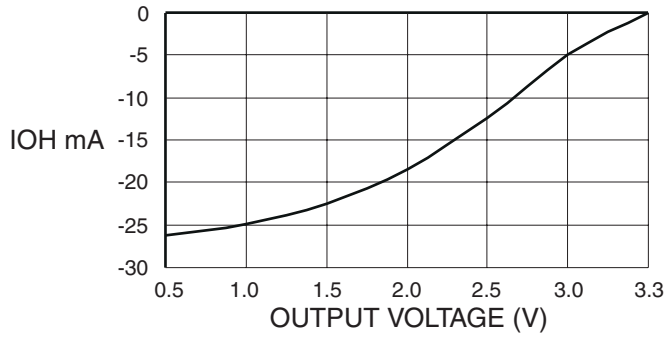

NORMALIZED  $t_{CO}$   
VS. AMBIENT TEMPERATURE (VCC = 3.3V)

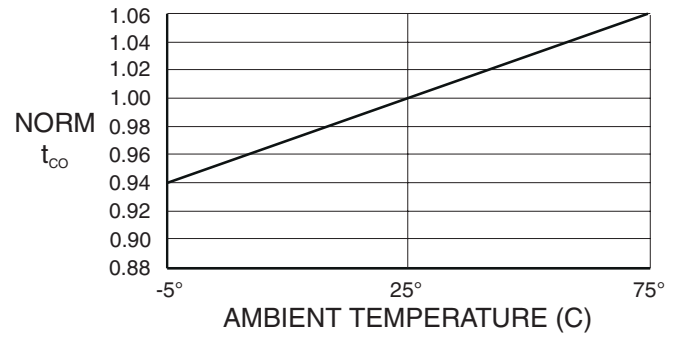

NORMALIZED  $t_{PD}$   
VS. SUPPLY VOLTAGE (TA = 25°C)

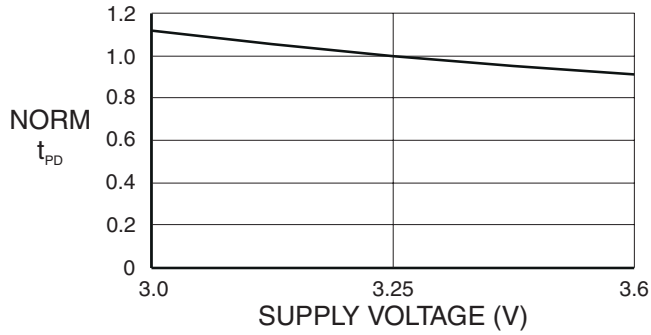

NORMALIZED  $t_s$   
VS. AMBIENT TEMPERATURE (VCC = 3.3V)

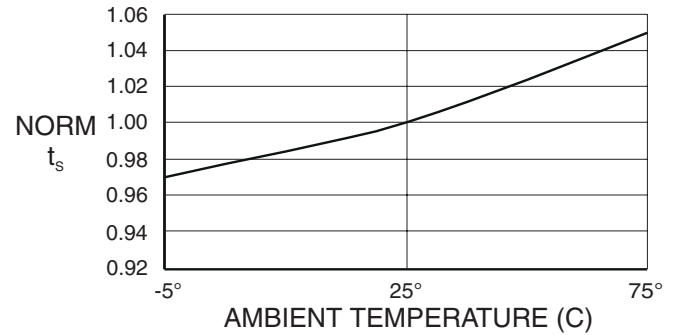

NORMALIZED  $t_{PD}$   
VS. AMBIENT TEMPERATURE (VCC = 3.3V)

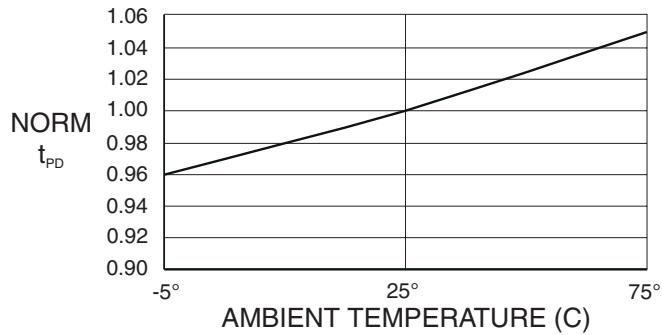

NORMALIZED  $t_H$   
VS. AMBIENT TEMPERATURE (VCC = 3.3V)

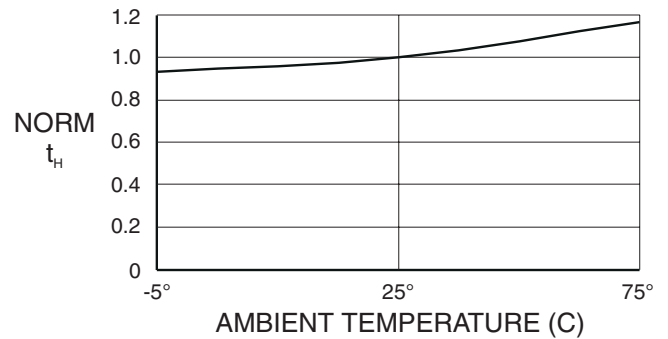



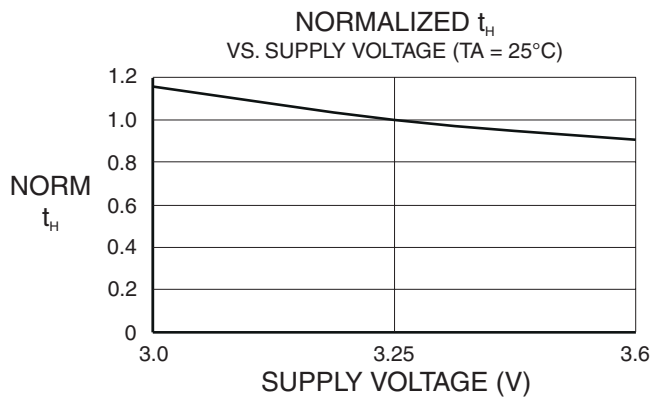
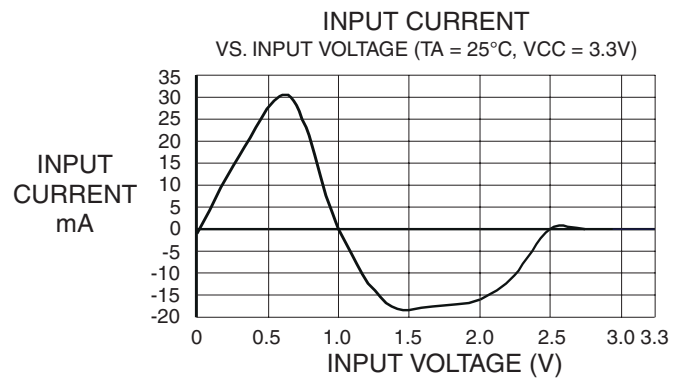
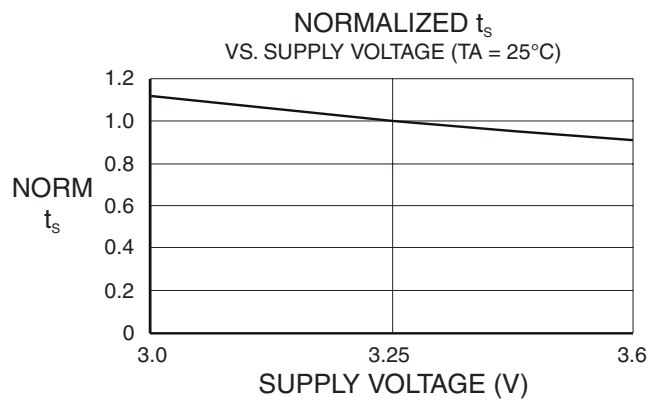
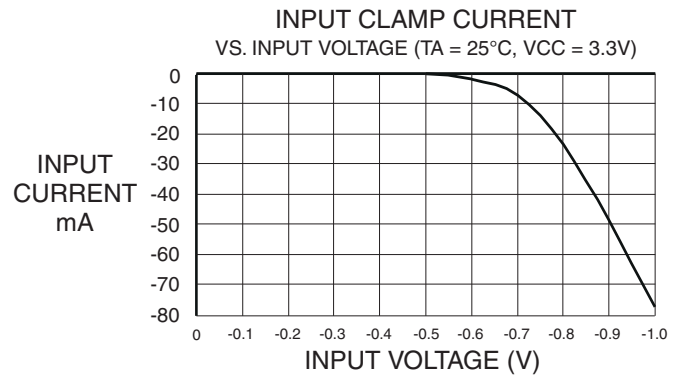
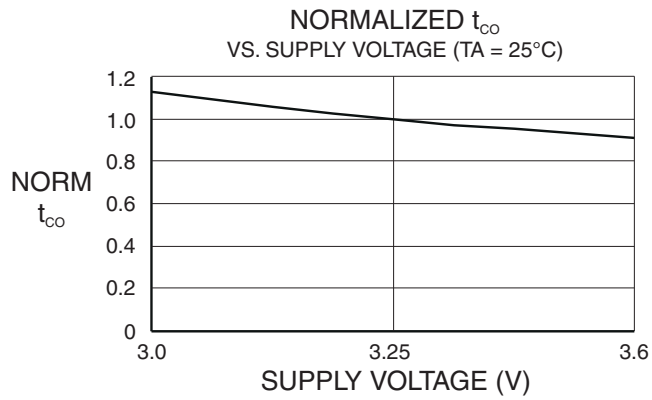

## Ordering Information

$t_{PD}$ (ns)	$t_S$ (ns)	$t_{CO}$ (ns)	Ordering Code	Package	Operation Range
10	7	7	ATF16LV8C-10JC ATF16LV8C-10PC ATF16LV8C-10SC ATF16LV8C-10XC	20J 20P3 20S 20X	Commercial (0°C to 70°C)
15	12	10	ATF16LV8C-15JC ATF16LV8C-15PC ATF16LV8C-15SC ATF16LV8C-15XC	20J 20P3 20S 20X	Commercial (0°C to 70°C)
10	7	7	ATF16LV8C-10JI ATF16LV8C-10PI ATF16LV8C-10SI ATF16LV8C-10XI	20J 20P3 20S 20X	Industrial (-40°C to 85°C)
15	12	10	ATF16LV8C-15JI ATF16LV8C-15PI ATF16LV8C-15SI ATF16LV8C-15XI	20J 20P3 20S 20X	Industrial (-40°C to 85°C)

## Green Package Options (Pb/Halide-free/RoHS Compliant)

$t_{PD}$ (ns)	$t_S$ (ns)	$t_{CO}$ (ns)	Ordering Code	Package	Operation Range
10	7	7	ATF16LV8C-10JU ATF16LV8C-10SU ATF16LV8C-10XU	20J 20S 20X	Industrial (-40°C to 85°C)

## Using “C” Product for Industrial

To use commercial product for industrial temperature ranges, simply de-rate  $I_{CC}$  by 15% on the “C” device. No speed de-rating is necessary.

Package Type	
<b>20J</b>	20-lead, Plastic J-leaded Chip Carrier (PLCC)
<b>20P3</b>	20-lead, 0.300" Wide, Plastic Dual Inline Package (PDIP)
<b>20S</b>	20-lead, 0.300" Wide, Plastic Gull-wing Small Outline (SOIC)
<b>20X</b>	20-lead, 4.4 mm Wide, Plastic Thin Shrink Small Outline (TSSOP)

# Packaging Information

## 20J – PLCC

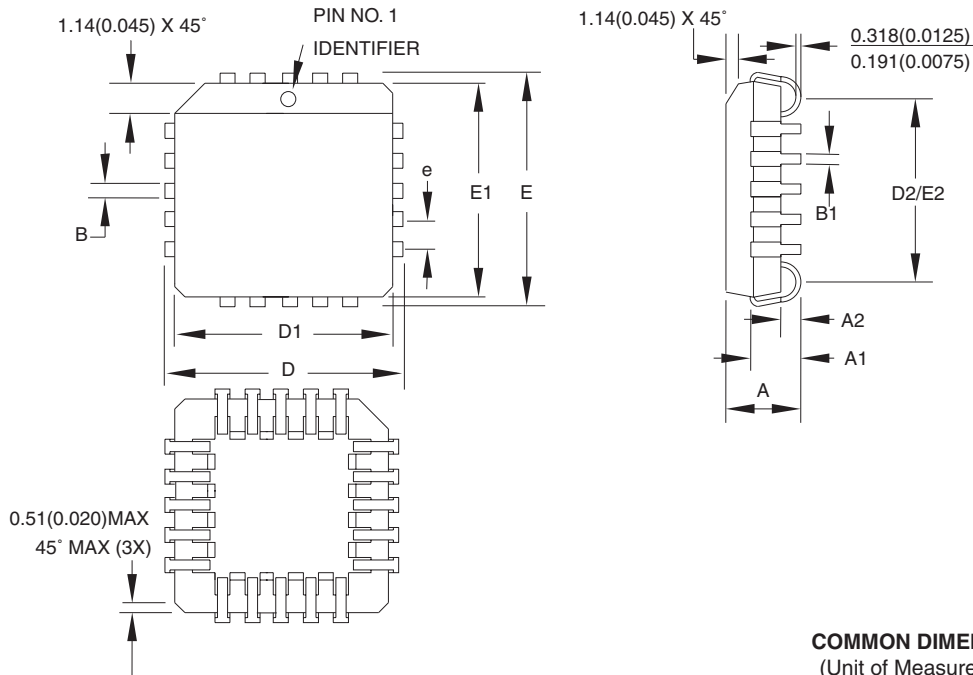

**COMMON DIMENSIONS**  
(Unit of Measure = mm)

SYMBOL	MIN	NOM	MAX	NOTE
A	4.191	–	4.572	
A1	2.286	–	3.048	
A2	0.508	–	–	
D	9.779	–	10.033	
D1	8.890	–	9.042	Note 2
E	9.779	–	10.033	
E1	8.890	–	9.042	Note 2
D2/E2	7.366	–	8.382	
B	0.660	–	0.813	
B1	0.330	–	0.533	
e	1.270 TYP			

- Notes:
1. This package conforms to JEDEC reference MS-018, Variation AA.
  2. Dimensions D1 and E1 do not include mold protrusion. Allowable protrusion is .010" (0.254 mm) per side. Dimension D1 and E1 include mold mismatch and are measured at the extreme material condition at the upper or lower parting line.
  3. Lead coplanarity is 0.004" (0.102 mm) maximum.

10/04/01



2325 Orchard Parkway  
San Jose, CA 95131

**TITLE**

**20J, 20-lead, Plastic J-leaded Chip Carrier (PLCC)**

**DRAWING NO.**

20J

**REV.**

B

## 20P3 – PDIP

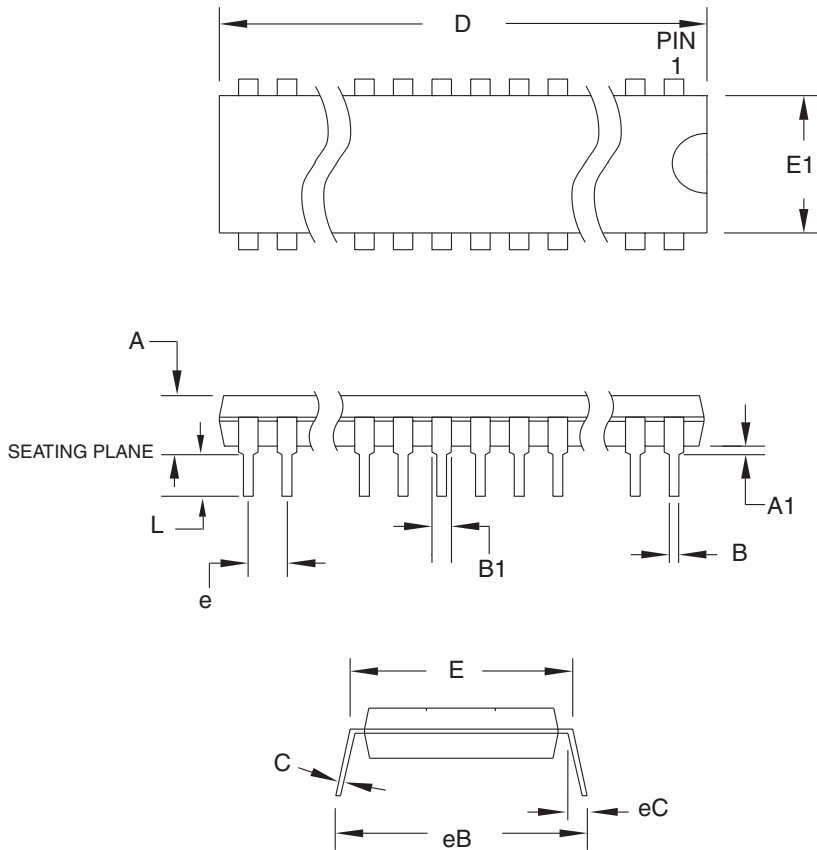

**COMMON DIMENSIONS**  
(Unit of Measure = mm)

SYMBOL	MIN	NOM	MAX	NOTE
A	–	–	5.334	
A1	0.381	–	–	
D	24.892	–	26.924	Note 2
E	7.620	–	8.255	
E1	6.096	–	7.112	Note 2
B	0.356	–	0.559	
B1	1.270	–	1.551	
L	2.921	–	3.810	
C	0.203	–	0.356	
eB	–	–	10.922	
eC	0.000	–	1.524	
e	2.540 TYP			

- Notes:
1. This package conforms to JEDEC reference MS-001, Variation AD.
  2. Dimensions D and E1 do not include mold Flash or Protrusion. Mold Flash or Protrusion shall not exceed 0.25 mm (0.010").

1/23/04



2325 Orchard Parkway  
San Jose, CA 95131

**TITLE**

**20P3**, 20-lead (0.300"/7.62 mm Wide) Plastic Dual  
Inline Package (PDIP)

**DRAWING NO.**

20P3

**REV.**

D



## 20S – SOIC

Dimensions in Millimeters and (Inches).  
 Controlling dimension: Inches.  
 JEDEC Standard MS-013

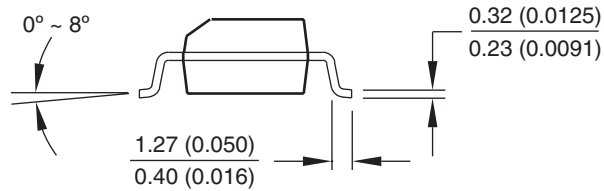
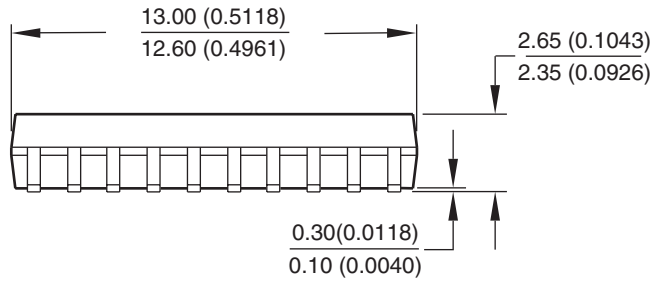
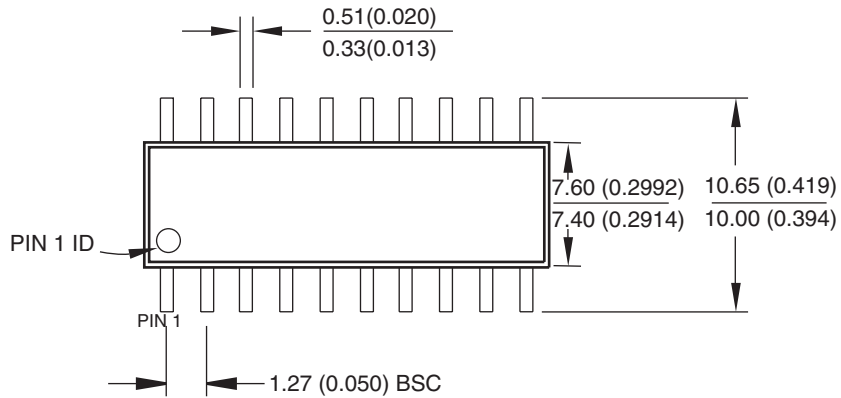

10/23/03



2325 Orchard Parkway  
 San Jose, CA 95131

**TITLE**

**20S, 20-lead, 0.300" Body, Plastic Gull Wing Small Outline (SOIC)**

**DRAWING NO.**

20S

**REV.**

B

## 20X – TSSOP

Dimensions in Millimeters and (Inches).  
 Controlling dimension: Millimeters.  
 JEDEC Standard MO-153 AC

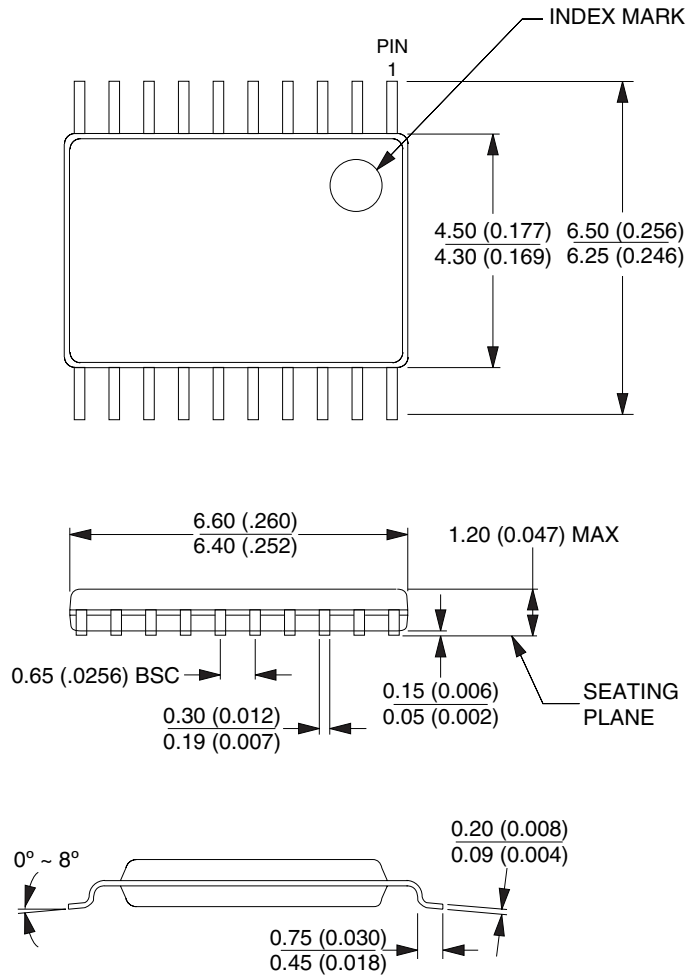

10/23/03



2325 Orchard Parkway  
 San Jose, CA 95131

**TITLE**

**20X**, (Formerly 20T), 20-lead, 4.4 mm Body Width,  
 Plastic Thin Shrink Small Outline Package (TSSOP)

**DRAWING NO.**

20X

**REV.**

C





## Revision History

Revision Level – Revision Date	History
H – June 2006	Added Green package options.



## Atmel Corporation

2325 Orchard Parkway  
San Jose, CA 95131, USA  
Tel: 1(408) 441-0311  
Fax: 1(408) 487-2600

## Regional Headquarters

### Europe

Atmel Sarl  
Route des Arsenaux 41  
Case Postale 80  
CH-1705 Fribourg  
Switzerland  
Tel: (41) 26-426-5555  
Fax: (41) 26-426-5500

### Asia

Room 1219  
Chinachem Golden Plaza  
77 Mody Road Tsimshatsui  
East Kowloon  
Hong Kong  
Tel: (852) 2721-9778  
Fax: (852) 2722-1369

### Japan

9F, Tonetsu Shinkawa Bldg.  
1-24-8 Shinkawa  
Chuo-ku, Tokyo 104-0033  
Japan  
Tel: (81) 3-3523-3551  
Fax: (81) 3-3523-7581

## Atmel Operations

### Memory

2325 Orchard Parkway  
San Jose, CA 95131, USA  
Tel: 1(408) 441-0311  
Fax: 1(408) 436-4314

### Microcontrollers

2325 Orchard Parkway  
San Jose, CA 95131, USA  
Tel: 1(408) 441-0311  
Fax: 1(408) 436-4314

La Chantrerie  
BP 70602  
44306 Nantes Cedex 3, France  
Tel: (33) 2-40-18-18-18  
Fax: (33) 2-40-18-19-60

### ASIC/ASSP/Smart Cards

Zone Industrielle  
13106 Rousset Cedex, France  
Tel: (33) 4-42-53-60-00  
Fax: (33) 4-42-53-60-01

1150 East Cheyenne Mtn. Blvd.  
Colorado Springs, CO 80906, USA  
Tel: 1(719) 576-3300  
Fax: 1(719) 540-1759

Scottish Enterprise Technology Park  
Maxwell Building  
East Kilbride G75 0QR, Scotland  
Tel: (44) 1355-803-000  
Fax: (44) 1355-242-743

### RF/Automotive

Theresienstrasse 2  
Postfach 3535  
74025 Heilbronn, Germany  
Tel: (49) 71-31-67-0  
Fax: (49) 71-31-67-2340

1150 East Cheyenne Mtn. Blvd.  
Colorado Springs, CO 80906, USA  
Tel: 1(719) 576-3300  
Fax: 1(719) 540-1759

### Biometrics/Imaging/Hi-Rel MPU/ High-Speed Converters/RF Datacom

Avenue de Rochepleine  
BP 123  
38521 Saint-Egreve Cedex, France  
Tel: (33) 4-76-58-30-00  
Fax: (33) 4-76-58-34-80

---

## Literature Requests

[www.atmel.com/literature](http://www.atmel.com/literature)

**Disclaimer:** The information in this document is provided in connection with Atmel products. No license, express or implied, by estoppel or otherwise, to any intellectual property right is granted by this document or in connection with the sale of Atmel products. **EXCEPT AS SET FORTH IN ATMEL'S TERMS AND CONDITIONS OF SALE LOCATED ON ATMEL'S WEB SITE, ATMEL ASSUMES NO LIABILITY WHATSOEVER AND DISCLAIMS ANY EXPRESS, IMPLIED OR STATUTORY WARRANTY RELATING TO ITS PRODUCTS INCLUDING, BUT NOT LIMITED TO, THE IMPLIED WARRANTY OF MERCHANTABILITY, FITNESS FOR A PARTICULAR PURPOSE, OR NON-INFRINGEMENT. IN NO EVENT SHALL ATMEL BE LIABLE FOR ANY DIRECT, INDIRECT, CONSEQUENTIAL, PUNITIVE, SPECIAL OR INCIDENTAL DAMAGES (INCLUDING, WITHOUT LIMITATION, DAMAGES FOR LOSS OF PROFITS, BUSINESS INTERRUPTION, OR LOSS OF INFORMATION) ARISING OUT OF THE USE OR INABILITY TO USE THIS DOCUMENT, EVEN IF ATMEL HAS BEEN ADVISED OF THE POSSIBILITY OF SUCH DAMAGES.** Atmel makes no representations or warranties with respect to the accuracy or completeness of the contents of this document and reserves the right to make changes to specifications and product descriptions at any time without notice. Atmel does not make any commitment to update the information contained herein. Unless specifically provided otherwise, Atmel products are not suitable for, and shall not be used in, automotive applications. Atmel's products are not intended, authorized, or warranted for use as components in applications intended to support or sustain life.

© 2006 Atmel Corporation. All rights reserved. Atmel®, logo and combinations thereof, Everywhere You Are® and others are registered trademarks or trademarks of Atmel Corporation or its subsidiaries. Other terms and product names may be trademarks of others.