



Welcome to E-XFL.COM

Understanding [Embedded - Microcontroller, Microprocessor, FPGA Modules](#)

Embedded - Microcontroller, Microprocessor, and FPGA Modules are fundamental components in modern electronic systems, offering a wide range of functionalities and capabilities. Microcontrollers are compact integrated circuits designed to execute specific control tasks within an embedded system. They typically include a processor, memory, and input/output peripherals on a single chip. Microprocessors, on the other hand, are more powerful processing units used in complex computing tasks, often requiring external memory and peripherals. FPGAs (Field Programmable Gate Arrays) are highly flexible devices that can be configured by the user to perform specific logic functions, making them invaluable in applications requiring customization and adaptability.

Applications of [Embedded - Microcontroller,](#)

Details

Product Status	Obsolete
Module/Board Type	FPGA Core
Core Processor	Artix-7 A35T
Co-Processor	-
Speed	200MHz
Flash Size	32MB
RAM Size	1GB
Connector Type	Samtec LSHM
Size / Dimension	1.97" x 1.57" (50mm x 40mm)
Operating Temperature	-40°C ~ 85°C
Purchase URL	https://www.e-xfl.com/product-detail/trenz-electronic/te0712-02-35-2i



TE0712 TRM

Revision: V14

Date: 07-Jun-2017 19:08

Table of Contents

Overview	3
Key Features	3
Block Diagram	4
Main Components	5
Initial Delivery State	5
Signals, Interfaces and Pins	6
Board to Board (B2B) I/Os	6
JTAG Interface	6
System Controller I/O Pins	7
On-board LEDs	7
Clocking	8
On-board Peripherals	9
32 MByte Quad SPI Flash Memory	9
System Controller CPLD	9
DDR3 SDRAM	9
Ethernet PHY	10
MAC Address EEPROM	10
Power and Power-On Sequence	11
Power Supply	11
Power-On Sequence	11
Power Rails	12
Board to Board Connectors	13
Connector Mechanical Ratings	13
Manufacturer Documentation	14
Variants Currently In Production	15
Technical Specifications	16
Absolute Maximum Ratings	16
Recommended Operating Conditions	16
Operating Temperature Ranges	16
Physical Dimensions	17
Weight	17
Revision History	18
Hardware Revision History	18
Document Change History	18
Disclaimer	19
Document Warranty	19
Limitation of Liability	19
Copyright Notice	19
Technology Licenses	19
Environmental Protection	19
REACH, RoHS and WEEE	20

Overview

Refer to <https://wiki.trenz-electronic.de/display/PD/TE0712+TRM> for online version of this manual and the rest of available documentation.

Trenz Electronic TE0712 is an industrial-grade FPGA module integrating a Xilinx Artix-7 FPGA, a 10/100 Mbit Ethernet transceiver, 1 GByte of DDR3 SDRAM, 32 MByte Flash memory for configuration and operation, and powerful switching-mode power supplies for all on-board voltages. Numerous configurable I/Os are provided via rugged high-speed strips. All this on a tiny footprint, smaller than a credit card size at very competitive price. All Trenz Electronic SoMs in 4 x 5 cm form factor are mechanically compatible.

Key Features

- Xilinx Artix-7 FPGA (15T to 200T) supported by the free [Xilinx Vivado WebPACK](#) software
- Both industrial and commercial temperature ranges available
- Rugged for high shock resistance and high vibration
- 1 GByte DDR3 32-bit SDRAM
- 10/100 Mbit Ethernet PHY
 - MAC address EEPROM
- 32 MByte QSPI Flash memory (with XiP support)
- Programmable clock generator
 - Transceiver clock (default 125 MHz)
 - Fabric clock (default 200 MHz)
- Plug-on module with 2 x 100-pin and 1 x 60-pin high-speed hermaphroditic strips
- 158 FPGA I/Os (78 differential pairs) available via board-to-board connectors
- 4 GTP (high-performance transceiver) lanes
 - GTP (high-performance transceiver) clock input
- On-board high-efficiency DC-DC converters
 - 12A x 1.0V power rail
 - 1.5A x 1.8V power rail
 - 1.5A x 1.5V power rail
- System management and power sequencing
- eFUSE bit-stream encryption
- AES bit-stream encryption
- User configurable LEDs
- Evenly-spread supply pins for good signal integrity

Additional assembly options are available for cost or performance optimization upon request.

Block Diagram

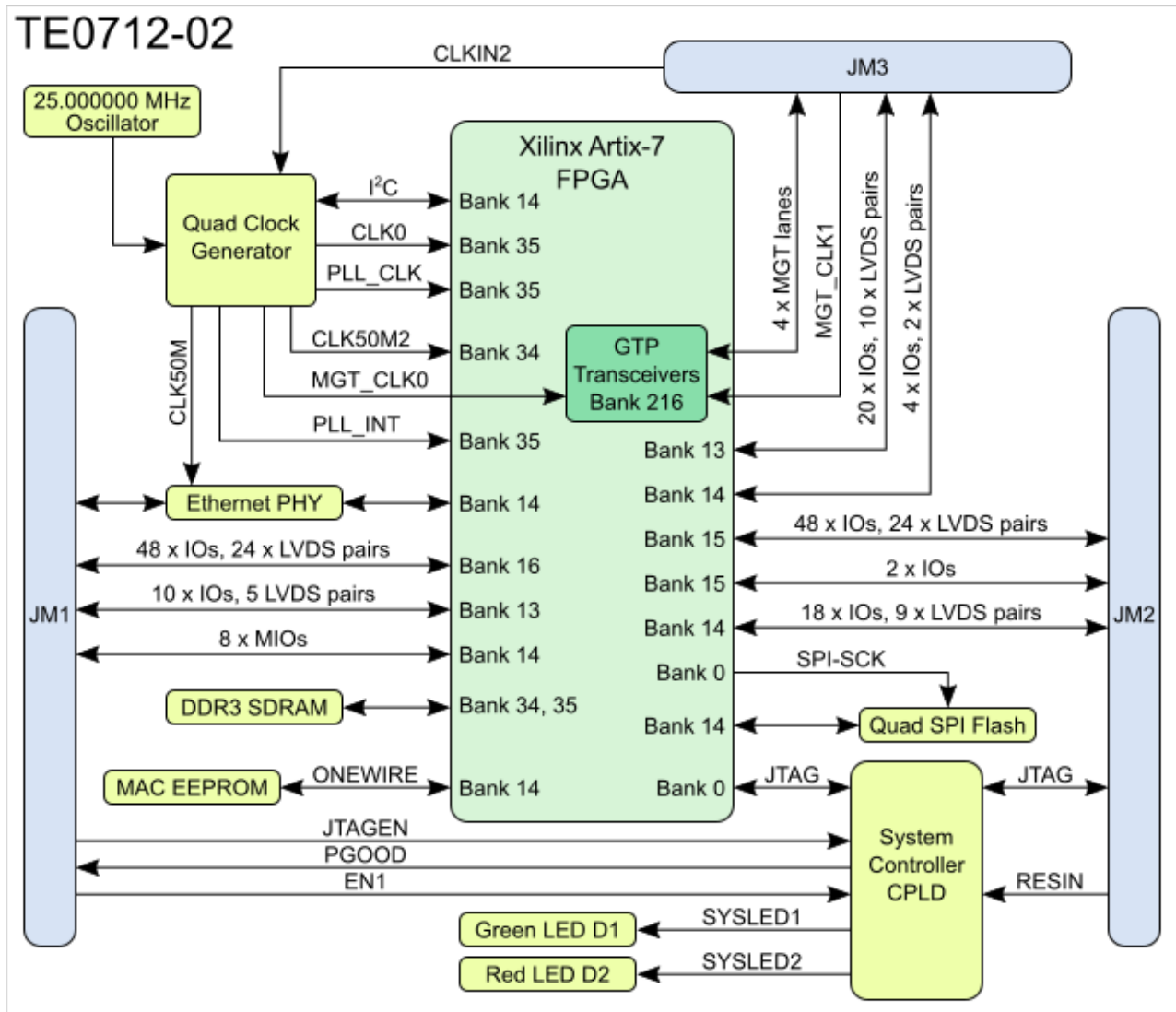

Main Components

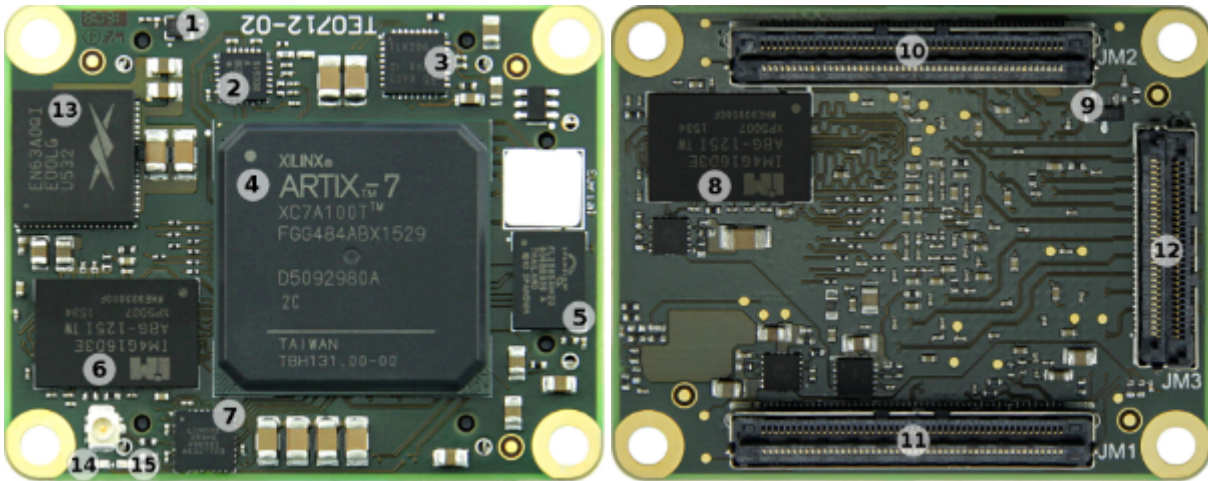

1. Programmable oscillator @25 MHz, SiTime SiT8008, U9
2. Programmable quad clock generator, Silicon Labs Si5338, U2
3. 10/100 Mbps Ethernet PHY transceiver, Texas Instruments TLK106, U5
4. Xilinx Artix-7 FPGA XC7A series, U1
5. 32 MByte QSPI Flash memory, Cypress S25FL256S, U4
6. 4 Gbit DDR3 SDRAM, Intelligent Memory IM4G16D3EABG, U15
7. System Controller CPLD, Lattice Semiconductor MachXO2-256HC, U3
8. 4 Gbit DDR3 SDRAM, Intelligent Memory IM4G16D3EABG, U19
9. Serial EEPROM, Microchip 11AA02E48, U7
10. Samtec Razor Beam™ LSHM-150 B2B connector , J M2
11. Samtec Razor Beam™ LSHM-150 B2B connector , J M1
12. Samtec Razor Beam™ LSHM-150 B2B connector , J M3
13. 12A Enpirion EN63A0QI PowerSoC DC-DC converter, U14
14. Green LED (SYSLED1), D1
15. Red LED (SYSLED2), D2

Initial Delivery State

Programmable unit	Content	Notes
Xilinx Artix-7 FPGA	Not programmed	U1
System Controller CPLD	Programmed	U3
SPI Flash OTP area	Empty	U4
SPI Flash main array	Empty	U4
SPI Flash Quad Enable bit	Set	U4
Microchip 11AA02E48	Globally unique EUI-48 (Ethernet MAC address)	U7

Signals, Interfaces and Pins

Board to Board (B2B) I/Os

FPGA bank number and number of I/O signals connected to the B2B connector:

FPGA Bank	B2B Connector	I/O Signal Count	Voltage Level	Notes
13	JM1	10	VCCIO13	Supplied by the baseboard.
13	JM3	20	VCCIO13	Supplied by the baseboard.
14	JM1	8	3.3V	
14	JM2	18	3.3V	
14	JM3	4	3.3V	
15	JM2	48	VCCIO15	Supplied by the baseboard.
15	JM2	2	VCCIO15	Supplied by the baseboard.
16	JM1	48	VCCIO16	Supplied by the baseboard.

Please refer to the [Pin-out](#) tables page for additional information.

JTAG Interface

JTAG access to the Xilinx Artix-7 FPGA and System Controller CPLD devices is provided through B2B connector JM2.

JTAG Signal	B2B Pin
TMS	JM2-93
TDI	JM2-95
TDO	JM2-97
TCK	JM2-99

JTAGEN pin in B2B connector JM1 is used to select JTAG access for FPGA or SC CPLD:

JTAGEN	JTAG Access To
Low	Artix-7 FPGA
High	System Controller CPLD

System Controller I/O Pins

Special purpose pins are connected to System Controller CPLD and have following default configuration:

Pin Name	Mode	Function	Default Configuration
PGOOD	Output	Power good	Active low when EN1 is low or module power is invalid.
JTAGEN	Input	JTAG select	Low for normal operation, high for System Controller CPLD access.
EN1	Input	Power Enable	When forced low, pulls POR_B low to emulate power on reset.
NOSEQ	-	No function	Not used.
MODE	-	No function	Not used.

Pin usages depends on CPLD Firmware, see: [TE0712 CPLD](#)

On-board LEDs

The TE0712 module has 2 LEDs which are connected to the System Controller CPLD. Once FPGA configuration has completed these can be used by the user's design.

LED	Color	SC Signal	SC Pin	Notes
D1	Green	SYSLED1	9	Exact function depends on System Controller CPLD firmware.
D2	Red	SYSLED2	8	Exact function depends on System Controller CPLD firmware.

Clocking

Si5338 programmable clock generator is used to generate different clocks with 25 MHz oscillator connected to pin IN3. The Si5338 can alternatively be clocked using pins IN1 and IN2 which are connected to B2B connector JM3 (CLKIN2).

The Si5338 can be programmed to change the output frequency of the FPGA clocks (the Ethernet clock must remain at 50 MHz). An I²C bus is connected between the FPGA (master) and clock generator (slave). Proper logic needs to be created in the FPGA to exercise the I²C bus with the correct data. See the reference design section for more information.

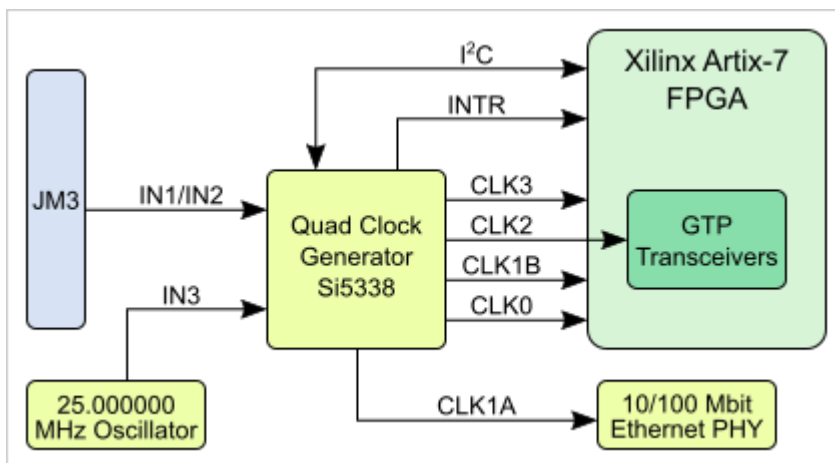

CLK Output	FPGA Bank	FPGA Pin	IO Standard	Net Name	Default Frequency	Notes
CLK0	34	K4/J4	DIFF_SSTL15	CLK0_P/N	--	NB! Since PCB REV02.
CLK1A	-	-		CLK50M	50 MHz	PHY chip RMI reference clock.
CLK1B	34	R4		CLK50M2	--	NB! Since PCB REV02.
CLK2	216	F6/E6	Auto	MGT_CLK0_P/N	125 MHz	GTP transceiver clock.
CLK3	35	H4/G4	DIFF_SSTL15	PLL_CLK_P/N	50 MHz	

Certain B2B connector pins are connected to the FPGA pins which are capable of handling clocking signals from the user's PCB (baseboard). See schematics B2B page for additional information.

On-board Peripherals

32 MByte Quad SPI Flash Memory

On-board QSPI flash memory S25FL256S (U14) is used to store initial FPGA configuration. Besides FPGA configuration, remaining free flash memory can be used for user application and data storage. All four SPI data lines are connected to the FPGA allowing x1, x2 or x4 data bus widths. Maximum data rate depends on the selected bus width and clock frequency used.

 SPI Flash QE (Quad Enable) bit must be set to high or FPGA is unable to load its configuration from flash during power-on. By default this bit is set to high at the manufacturing plant.

System Controller CPLD

System Controller CPLD (Lattice MachXO2-256HC, U3) is used to control FPGA configuration process. The FPGA is held in reset (by driving the PROG_B signal low) until all power supplies have stabilized.

By driving signal RESIN to low you can reset the FPGA. This signal can be driven from the user's baseboard PCB via the B2B connector JM2 pin 18.

Input EN1 is also gated to FPGA reset, should be open or pulled up for normal operation. By driving EN1 low, on-board DC-DC converters will be not turned off.

User can create their own System Controller design using [Lattice Diamond](#) software. Once created it can be programmed into CPLD via JTAG interface.

DDR3 SDRAM

The TE0712-02 SoM has two 4 Gbit volatile DDR3 SDRAM ICs (U15 and U19) for storing user application code and data.

- Part number: IM4G16D3FABG-125I
- Supply voltage: 1.5V
- Organization: 32M words x 16 bits x 8 banks
- Memory speed: limited by Xilinx Artix-7 speed grade and MIG

Configuration of the DDR3 memory controller in the FPGA should be done using the MIG tool in the Xilinx Vivado Design Suite IP catalog.

Ethernet PHY

The 10/100 Mbps Ethernet PHY TLK106 (U5) by Texas Instruments is connected to the FPGA bank 14 using Reduced Media Independent Interface standard (RMII). The RMII standard has reduced set of data lines (two rather than four) and a higher clock frequency (50 MHz rather than 25 MHz) compared to the Media Independent Interface standard (MII). A management interface is also available allowing access to registers in the PHY chip. Transmit and receive signals are connected to the B2B connector JM1. The magnetics and RJ-45 jack must be placed on the user's PCB (baseboard).

FPGA Ethernet Signals

FPGA Pin	Signal Name	Signal Description
N17	ETH-RST	Ethernet reset, active-low.
N15	LINK_LED	Ethernet LED pin indication mode: in mode 1 - LINK, in mode 2 - ACT.
R16	MDC	Ethernet management clock.
P17	MDIO	Ethernet management data.
P14	ETH_TX_D0	Ethernet transmit data 0. Output to Ethernet PHY.
P15	ETH_TX_D1	Ethernet transmit data 1. Output to Ethernet PHY.
R14	ETH_TX_EN	Ethernet transmit enable.
N13	ETH_RX_D0	Ethernet receive data 0. Input from Ethernet PHY.
N14	ETH_RX_D1	Ethernet receive data 0. Input from Ethernet PHY.
P20	ETH_RX_DV	Ethernet receive data valid.

All signals are connected to the FPGA bank 14 and correspond to LVCMOS33 standard.

MAC Address EEPROM

TE0712-02 module has a 2 Kbit Serial Electrically Erasable PROM (EEPROM, U7). It provides pre-programmed 48-bit Extended Unique Identifier (EUI-48™) to identify network hardware MAC address which is write-protected to ensure tamper-proof designs. This SEEPROM can be accessed by UNI/O® serial interface bus using Manchester encoding techniques. The clock and data are combined into a single, serial bit stream (SCIO), where the clock signal is extracted by the receiver to correctly decode the timing and value of each bit. The bus is controlled by a master device (Xilinx Artix-7) which determines the clock period, controls the bus access and initiates all operations, while the SEEPROM works as a slave. Refer to Microchip's 11AA02E48 datasheet for more information.

Power and Power-On Sequence

Power Supply

Single 3.3V power supply (for both VIN and 3.3VIN power rails) with minimum current capability of 3A for system startup is recommended.

Power Consumption

Typical module power consumption is between 2-3W. Exact power consumption is to be determined.

TE0712-02 module can also be powered by split 5V/3.3V power sources if preferred. In such case apply 5V to B2B connectors VIN pins and 3.3V to 3.3VIN pins, although lowest power consumption is achieved when powering the module from single 3.3V supply. When using split 5V/3.3V supplies the power consumption (and heat dissipation) will rise due to the DC-DC converter efficiency (it decreases when VIN/VOUT ratio rises).

Power-On Sequence

For the highest efficiency of the on-board DC-DC regulators, it is recommended to use same 3.3V power source for both VIN and 3.3VIN power rails. Although VIN and 3.3VIN can be powered up in any order, it is recommended to power them up simultaneously.

It is important that all baseboard I/Os are 3-stated at power-on until System Controller sets PGOOD signal high (B2B connector JM1, pin 30), or 3.3V is present on B2B connector JM2 pins 10 and 12, meaning that all on-module voltages have become stable and module is properly powered up.

See Xilinx datasheet DS181 - "Artix-7 FPGAs Data Sheet: DC and AC Switching Characteristics" for additional information. User should also check related baseboard documentation when choosing baseboard design for TE0712 module.

Power Rails

Power Rail Name	B2B Connector JM1 Pin	B2B Connector JM2 Pin	Direction	Notes
VIN	1, 3, 5	2, 4, 6, 8	Input	SoM supply voltage (from the baseboard).
3.3VIN	13, 15	-	Input	SoM supply voltage (from the baseboard).
1.5V	-	19	Output	Module internal 1.5V level.
1.8V	39	-	Output	Module internal 1.8V level. Maximum 300mA available.
3.3V	14	10, 12	Output	Module internal 3.3V level.
VCCIO13	-	1, 3	Input	High-Range bank supply voltage (from the baseboard).
VCCIO15	-	7, 9	Input	High-Range bank supply voltage (from the baseboard).
VCCIO16	9, 11	-	Input	High-Range bank supply voltage (from the baseboard).
VREF_JTAG	-	91	Output	JTAG reference voltage (3.3V).

Board to Board Connectors

 These connectors are hermaphroditic. Odd pin numbers on the module are connected to even pin numbers on the baseboard and vice versa.

Trenz Electronic 4 x 5 modules use two or three Samtec Razor Beam™ LSHM connectors on the bottom side.

- 2 x REF-189016-02 (compatible to LSHM-150-04.0-L-DV-A-S-K-TR), (100 pins, "50" per row)
- 1 x REF-189017-02 (compatible to LSHM-130-04.0-L-DV-A-S-K-TR), (60 pins, "30" per row) (depending on module)

When using the same type on baseboard, the mating height is 8mm. Other mating heights are possible by using connectors with a different height:

Connector on baseboard	compatible to	Mating height
REF-189016-01	LSHM-150-02.5-L-DV-A-S-K-TR	6.5 mm
LSHM-150-03.0-L-DV-A-S-K-TR	LSHM-150-03.0-L-DV-A-S-K-TR	7.0 mm
REF-189016-02	LSHM-150-04.0-L-DV-A-S-K-TR	8.0 mm
LSHM-150-06.0-L-DV-A-S-K-TR	LSHM-150-06.0-L-DV-A-S-K-TR	10.0mm
REF-189017-01	LSHM-130-02.5-L-DV-A-S-K-TR	6.5 mm
LSHM-130-03.0-L-DV-A-S-K-TR	LSHM-130-03.0-L-DV-A-S-K-TR	7.0 mm
REF-189017-02	LSHM-130-04.0-L-DV-A-S-K-TR	8.0 mm
LSHM-130-06.0-L-DV-A-S-K-TR	LSHM-130-06.0-L-DV-A-S-K-TR	10.0mm

The module can be manufactured using other connectors upon request.

The LSHM connector speed rating depends on the stacking height, please see the following table:

Stacking height	Speed rating
12 mm, Single-ended	7.5 GHz / 15 Gbps
12 mm, Differential	6.5 GHz / 13 Gbps
5 mm, Single-ended	11.5 GHz / 23 Gbps
5 mm, Differential	7.9 GHz / 14 Gbps

Connector Mechanical Ratings

- Shock: 100G, 6 ms sine
- Vibration: 7.5G random, 3 hours 3 axis

Manufacturer Documentation

Name	Version	Date
LSHM-1XX-XX.X-X-DV-A-X-X-TR-FOOTPRINT(1).pdf	1	2013-11-28 16:54
LSHM-1XX-XX.X-XX-DV-A-X-X-TR-MKT.pdf	1	2013-11-28 16:56
REF-189016-01.pdf	1	2015-10-30 11:54
REF-189016-02.pdf	1	2015-10-30 11:54
REF-189017-01.pdf	1	2015-10-30 11:54
REF-189017-02.pdf	1	2015-10-30 11:54
TC0923--2523_report_Rev_2_qua.pdf	1	2013-11-28 16:55
hsc-report_lshm-lshm-05mm_web.pdf	1	2013-11-28 16:56
lshm_dv.pdf	1	2013-11-28 16:56
tc0929--2611_qua(1).pdf	1	2013-11-28 16:55

Variants Currently In Production

Module Variant	FPGA	Junction Temperature	Temperature Range	B2B Connector Height
TE0712-02-35-2I	XC7A35T-2FGG484I	-40°C to 85°C	Industrial grade	4.0 mm
TE0712-02-100-1I	XC7A100T-1FGG484I	-40°C to 85°C	Industrial grade	4.0 mm
TE0712-02-200-1I	XC7A200T-1FBG484I	-40°C to 85°C	Industrial grade	4.0 mm
TE0712-02-200-2I	XC7A200T-2FBG484I	-40°C to 85°C	Industrial grade	4.0 mm
TE0712-02-200-1I3	XC7A200T-1FBG484I	-40°C to 85°C	Industrial grade	2.5 mm
TE0712-02-100-2C	XC7A100T-2FGG484C	0°C to 85°C	Commercial grade	4.0 mm
TE0712-02-100-2C3	XC7A100T-2FGG484C	0°C to 85°C	Commercial grade	2.5 mm
TE0712-02-200-2C	XC7A200T-2FBG484C	0°C to 85°C	Commercial grade	4.0 mm
TE0712-02-200-2C3	XC7A200T-2FBG484C	0°C to 85°C	Commercial grade	2.5 mm

Technical Specifications

Absolute Maximum Ratings

Parameter	Min	Max	Units	Reference Document
VIN supply voltage	-0.3	6.5	V	EP53F8QI datasheet.
3.3VIN supply voltage	-0.3	6.0	V	TPS748 datasheet.
HR I/O banks supply voltage (VCCO)	-0.5	3.6	V	Xilinx datasheet DS181
HR I/O banks input voltage	-0.4	VCCO + 0.55	V	Xilinx datasheet DS181
GTP transceivers Tx/Rx input voltage	-0.5	1.26	V	Xilinx datasheet DS181
Storage temperature	-55	100	°C	See IM4G16D3EABG datasheet.

Recommended Operating Conditions

Parameter	Min	Max	Units	Reference Document
VIN supply voltage	2.4	5.5	V	EP53F8QI datasheet.
3.3VIN supply voltage	2.9	5.5	V	TPS748 datasheet.
HR I/O banks supply voltage (VCCO)	1.14	3.465	V	Xilinx datasheet DS181
HR I/O banks input voltage	-0.20	VCCO + 0.2	V	Xilinx datasheet DS181

Operating Temperature Ranges

Commercial grade: 0°C to +70°C.

Industrial grade: -40°C to +85°C.

Operating temperature range depends also on customer design and cooling solution. Please contact us for options.



Assembly variants for higher storage temperature range are available on request.

Physical Dimensions

- Module size: 50 mm x 40 mm. Please download the assembly diagram for exact numbers.
- Mating height with standard connectors: 8mm
- PCB thickness: 1.6mm
- Highest part on PCB: approx. 2.5mm. Please download the step model for exact numbers.

All dimensions are shown in millimeters.

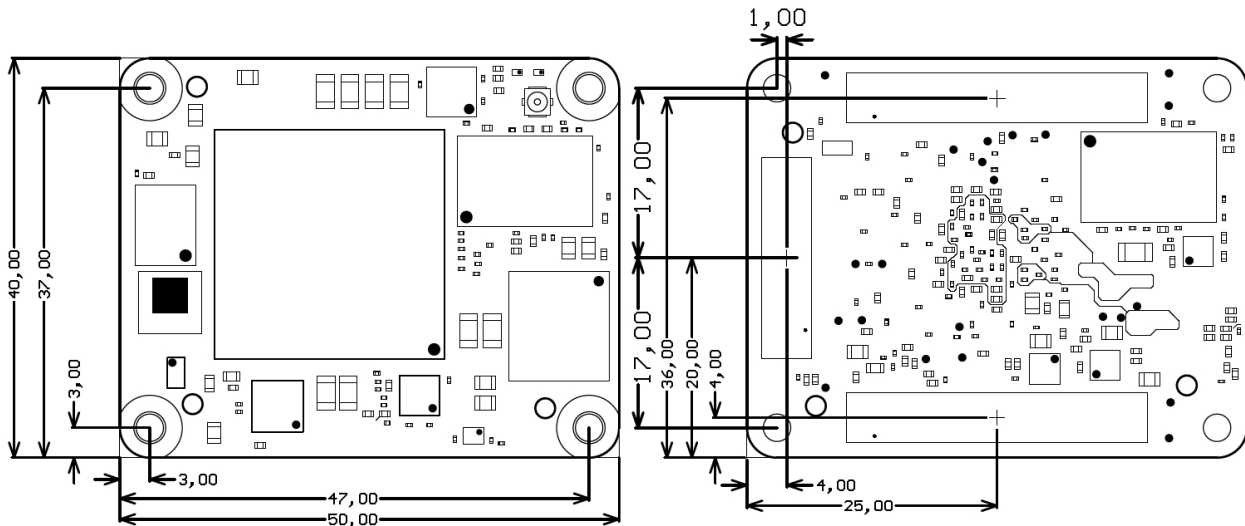

Weight

16 - 27 g, Plain module (depends on variant).

8.8 g, Set of nuts and bolts.

Revision History

Hardware Revision History

Date	Revision	Notes	PCN	Documentation Link
2016-12-09	02	Second production revision	Click to see PCN	TE0712-02
2013-12-02	01	First production revision		TE0712-01

Hardware revision number is printed on the PCB board together with the module model number separated by the dash.



Document Change History

Date	Revision	Contributors	Description
2017-05-29	V14	Jan Kumann	Variants table added. Key Features section relocated.
2017-03-01	V3.2	John Hartfiel	BUGFIX in the description of System Controller I/O section
2017-03-01	v3.1	John Hartfiel	Update Clocking Section
2017-01-26	V3	Jan Kumann	New block diagram. Few corrections.
2017-01-20	V2	Jan Kumann	Revised version.
2013-12-02	V0.1	Antti Lukats	Work in progress.

Disclaimer

Document Warranty

The material contained in this document is provided “as is” and is subject to being changed at any time without notice. Trenz Electronic does not warrant the accuracy and completeness of the materials in this document. Further, to the maximum extent permitted by applicable law, Trenz Electronic disclaims all warranties, either express or implied, with regard to this document and any information contained herein, including but not limited to the implied warranties of merchantability, fitness for a particular purpose or non infringement of intellectual property. Trenz Electronic shall not be liable for errors or for incidental or consequential damages in connection with the furnishing, use, or performance of this document or of any information contained herein.

Limitation of Liability

In no event will Trenz Electronic, its suppliers, or other third parties mentioned in this document be liable for any damages whatsoever (including, without limitation, those resulting from lost profits, lost data or business interruption) arising out of the use, inability to use, or the results of use of this document, any documents linked to this document, or the materials or information contained at any or all such documents. If your use of the materials or information from this document results in the need for servicing, repair or correction of equipment or data, you assume all costs thereof.

Copyright Notice

No part of this manual may be reproduced in any form or by any means (including electronic storage and retrieval or translation into a foreign language) without prior agreement and written consent from Trenz Electronic.

Technology Licenses

The hardware / firmware / software described in this document are furnished under a license and may be used /modified / copied only in accordance with the terms of such license.

Environmental Protection

To confront directly with the responsibility toward the environment, the global community and eventually also oneself. Such a resolution should be integral part not only of everybody's life. Also enterprises shall be conscious of their social responsibility and contribute to the preservation of our common living space. That is why Trenz Electronic invests in the protection of our Environment.

REACH, RoHS and WEEE

REACH

Trenz Electronic is a manufacturer and a distributor of electronic products. It is therefore a so called downstream user in the sense of [REACH](#). The products we supply to you are solely non-chemical products (goods). Moreover and under normal and reasonably foreseeable circumstances of application, the goods supplied to you shall not release any substance. For that, Trenz Electronic is obliged to neither register nor to provide safety data sheet. According to present knowledge and to best of our knowledge, no [SVHC \(Substances of Very High Concern\) on the Candidate List](#) are contained in our products. Furthermore, we will immediately and unsolicited inform our customers in compliance with REACH - Article 33 if any substance present in our goods (above a concentration of 0,1 % weight by weight) will be classified as SVHC by the [European Chemicals Agency \(ECHA\)](#).

RoHS

Trenz Electronic GmbH herewith declares that all its products are developed, manufactured and distributed RoHS compliant.

WEEE

Information for users within the European Union in accordance with Directive 2002/96/EC of the European Parliament and of the Council of 27 January 2003 on waste electrical and electronic equipment (WEEE).

Users of electrical and electronic equipment in private households are required not to dispose of waste electrical and electronic equipment as unsorted municipal waste and to collect such waste electrical and electronic equipment separately. By the 13 August 2005, Member States shall have ensured that systems are set up allowing final holders and distributors to return waste electrical and electronic equipment at least free of charge. Member States shall ensure the availability and accessibility of the necessary collection facilities. Separate collection is the precondition to ensure specific treatment and recycling of waste electrical and electronic equipment and is necessary to achieve the chosen level of protection of human health and the environment in the European Union. Consumers have to actively contribute to the success of such collection and the return of waste electrical and electronic equipment. Presence of hazardous substances in electrical and electronic equipment results in potential effects on the environment and human health. The symbol consisting of the crossed-out wheeled bin indicates separate collection for waste electrical and electronic equipment.

Trenz Electronic is registered under WEEE-Reg.-Nr. DE97922676.