

Welcome to [E-XFL.COM](https://www.e-xfl.com)

Understanding Embedded - PLDs (Programmable Logic Devices)

Embedded - PLDs, or Programmable Logic Devices, are a type of digital electronic component used to build reconfigurable digital circuits. Unlike fixed-function logic devices, PLDs can be programmed to perform specific functions by the user. This flexibility allows designers to customize the logic to meet the exact needs of their applications, making PLDs a crucial component in modern embedded systems.

Applications of Embedded - PLDs (Programmable Logic Devices)

The versatility of PLDs makes them suitable for a wide range of applications. In consumer electronics, PLDs are used to enhance the functionality and performance of

Details

Product Status	Obsolete
Programmable Type	EPLD
Number of Macrocells	10
Voltage - Input	3V
Speed	25 ns
Mounting Type	Surface Mount
Package / Case	24-SOIC (0.295", 7.50mm Width)
Supplier Device Package	24-SOIC
Purchase URL	https://www.e-xfl.com/product-detail/microchip-technology/at22lv10-25si

Features

- Low-voltage Programmable Logic Device
 - Wide Power Supply Range - 3.0V to 5.5V
 - Ideal for Battery Powered Systems
- High-speed Operation
 - 20 ns Maximum Propagation Delay at $V_{CC} = 3.0V$
- Commercial and Industrial Temperature Ranges
- Familiar 22V10 Logic Architecture
- Low-power 3-volt CMOS Operation

	AT22LV10L	AT22LV10
Temp	Com./Ind.	Com./Ind.
I_{CC} (mA)	4/5	35/45

$V_{CC} = 3.6V$

- CMOS and TTL Compatible Inputs and Outputs
 - 10 μA Leakage Maximum
- Reprogrammable – Tested 100% for Programmability
- High-reliability CMOS Technology
 - 2000V ESD Protection
 - 200 mA Latchup Immunity
- Dual-in-line and Surface Mount Packages

Logic Diagram

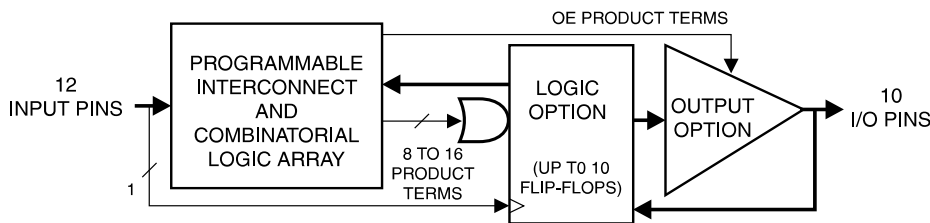

Description

The AT22LV10 and AT22LV10L are low-voltage compatible CMOS high-performance Programmable Logic Devices (PLDs). Speeds down to 20 ns and power dissipation as low as 14.4 mW are offered. All speed ranges are specified over the 3.0V to 5.5V range. All pins offer a low $\pm 10 \mu A$ leakage.

The AT22LV10L provides the optimum low-power CMOS PLD solution, with low DC power (1 mA typical at $V_{CC} = 3.3V$) and full CMOS output levels. The AT22LV10L significantly reduces total system power, allowing battery powered operation.

(continued)

Pin Configurations

All Pinouts Top View

Pin Name	Function
CLK/IN	Clock and Logic Input
IN	Logic Inputs
I/O	Bidirectional Buffers
*	No Internal Connection
VCC	3.0V to 5.5V Supply

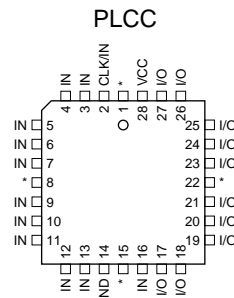
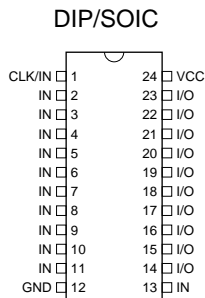

Rev. 0190E-08/99



Low-voltage UV
Erasable
Programmable
Logic Device

AT22LV10
AT22LV10L



Full CMOS output levels help reduce power in many other system components.

The AT22LV10 and AT22LV10L logic architectures are identical to the familiar 22V10. Each output is allocated from eight to 16 product terms, which allows highly complex logic functions to be realized.

Two additional product terms are included to provide synchronous preset and asynchronous reset. These terms are common to all ten registers. All registers are automatically cleared upon power-up.

Register preload simplifies testing. A security fuse prevents unauthorized copying of programmed fuse patterns.

Absolute Maximum Ratings*

Temperature Under Bias.....	-55°C to +125°C
Storage Temperature.....	-65°C to +150°C
Voltage on Any Pin with Respect to Ground.....	-2.0V to +7.0V ⁽¹⁾
Voltage on Input Pins with Respect to Ground During Programming.....	-2.0V to +14.0V ⁽¹⁾
Programming Voltage with Respect to Ground.....	-2.0V to +14.0V ⁽¹⁾
Integrated UV Erase Dose.....	7258 W·sec/cm ²

*NOTICE: Stresses beyond those listed under “Absolute Maximum Ratings” may cause permanent damage to the device. This is a stress rating only and functional operation of the device at these or any other conditions beyond those indicated in the operational sections of this specification is not implied. Exposure to absolute maximum rating conditions for extended periods may affect device reliability.

Note: 1. Minimum voltage is -0.6V DC which may undershoot to -2.0V for pulses of less than 20 ns. Maximum pin voltage is $V_{CC} + 0.75V$ DC which may undershoot to $V_{CC} + 2.0V$ for pulses of less than 20 ns.

DC and AC Operating Conditions

	Commercial	Industrial
Operating Temperature (Ambient)	0°C - 70°C	-40°C - 85°C
V_{CC} Power Supply	3.0V to 5.5V	3.0V to 5.5V

Logic Options

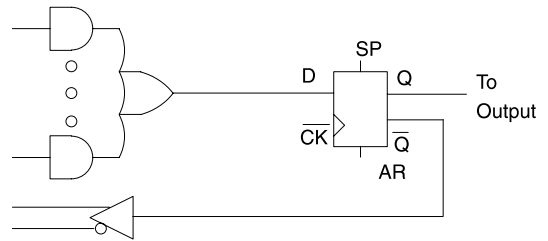
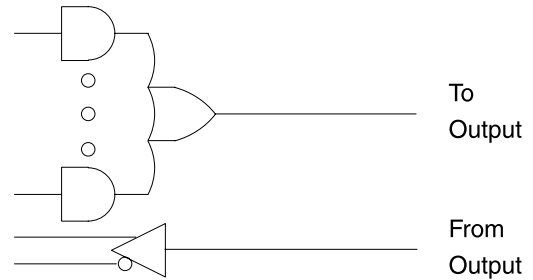

Output Options

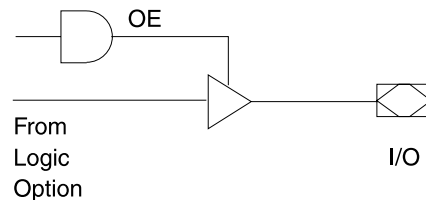
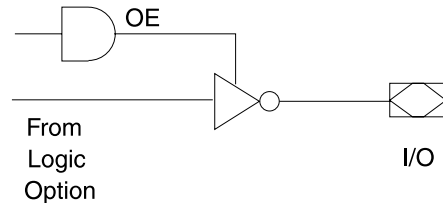

DC Characteristics

Symbol	Parameter	Condition ⁽²⁾			Min	Typ	Max	Units
I_{LI}	Input Load Current	$V_{IN} = -0.1V$ to $V_{CC} + 1V$					10	μA
I_{LO}	Output Leakage Current	$V_{OUT} = -0.1V$ to $V_{CC} + 0.1V$					10	μA
I_{CC}	Power Supply Current	$V_{CC} = 3.6V/5.5V$, $V_{IN} = GND$, Outputs Open	AT22LV10	Com.		20/50	35/90	mA
				Ind.		20/50	45/100	mA
			AT22LV10L	Com.		1/2	4/12	mA
				Ind.		1/2	5/15	mA
$I_{OS}^{(1)}$	Output Short Circuit Current	$V_{OUT} = 0.5V$					-120	mA
V_{IL1}	Input Low Voltage	$4.5V \leq V_{CC} \leq 5.5V$			-0.6		0.8	V
V_{IL2}	Input Low Voltage	$3.0V \leq V_{CC} < 4.5V$			-0.6		0.6	V
V_{IH}	Input High Voltage				2.0		$V_{CC} + 0.75$	V
V_{OL}	Output Low Voltage $V_{IN} = V_{IH}$ or V_{IL}	$V_{CC} = 3.0V$	Com., Ind.	$I_{OL} = 8$ mA			0.5	V
		$V_{CC} = 4.5V$	Com., Ind.	$I_{OL} = 16$ mA			0.5	V
		$V_{CC} = 3.0V$	Com., Ind.	$I_{OL} = 6$ mA			0.35	V
V_{OH}	Output High Voltage	$V_{IN} = V_{IH}$ or V_{IL} , $V_{CC} = 3.0V/4.5V$	$I_{OH} = -100$ μA		$V_{CC} - 0.3$			V
			$I_{OH} = -0.4$ mA/-4.0 mA		2.4			V

- Notes: 1. Not more than one output at a time should be shorted. Duration of short circuit test should not exceed 30 sec.
 2. For DC characteristics, the test condition of $V_{CC} = \text{Max}$ corresponds to 3.6V.

AC Characteristics for the AT22LV10

Symbol	Parameter	AT22LV10-20			AT22LV10-25			Units
		Min	Typ	Max	Min	Typ	Max	
t_{PD}	Input or Feedback to Non-Registered Output		12	20		15	25	ns
t_{EA}	Input to Output Enable			20		15	25	ns
t_{ER}	Input to Output Disable			20		15	25	ns
t_{CF}	Clock to Feedback	0	4	9	0	5	9	ns
t_{CO}	Clock to Output	0	8	14	0	10	17	ns
t_S	Input or Feedback Setup Time	10	6		12	7		ns
t_H	Hold Time	0			0			ns
t_P	Clock Period	10			12			ns
t_W	Clock Width	5			6			ns
F_{MAX}	External Feedback $1/(t_S+t_{CO})$			41.6			34.5	MHz
	Internal Feedback $1/(t_S + t_{CF})$			52.6			47.6	MHz
	No Feedback $1/(t_P)$			100.0			83.3	MHz
t_{AW}	Asynchronous Reset Width	20	12		25	15		ns
t_{AR}	Asynchronous Reset, Synchronous Preset, Recovery Time	20	12		25	15		ns
t_{AP}	Asynchronous Reset to Registered Output Reset		15	25		18	28	ns

AC Waveforms⁽¹⁾

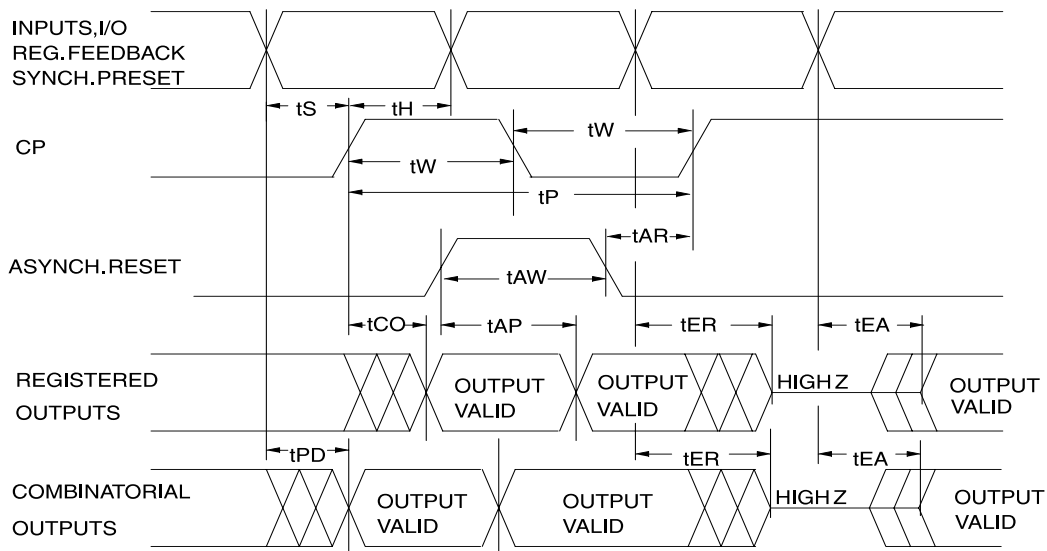

Note: 1. Timing measurement reference is 1.5V. Input AC driving levels are 0.0V and 3.0V, unless otherwise specified.

AC Characteristics for the AT22LV10L

Symbol	Parameter	AT22LV10L-25			Units
		Min	Typ	Max	
t_{PD}	Input or Feedback to Non-Registered Output		15	25	ns
t_{EA}	Input to Output Enable		15	25	ns
t_{ER}	Input to Output Disable		15	25	ns
t_{CF}	Clock to Feedback	0	5	9	ns
t_{CO}	Clock to Output	0	10	14	ns
t_{SF}	Feedback Setup Time	12	7		ns
t_S	Input Setup Time	17	15		ns
t_H	Hold Time	0			ns
t_P	Clock Period	12			ns
t_W	Clock Width	6			ns
F_{MAX}	External Feedback $1/(t_S + t_{CO})$			32.2	MHz
	Internal Feedback $1/(t_{SF} + t_{CF})$			47.6	MHz
	No Feedback $1/(t_P)$			83.3	MHz
t_{AW}	Asynchronous Reset Width	25	15		ns
t_{AR}	Asynchronous Reset Recovery Time	25	15		ns
t_{AP}	Asynchronous Reset to Registered Output Reset		18	28	ns

Input Test Waveforms and Measurement Levels

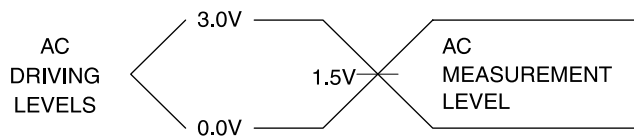

Output Test Loads

Commercial

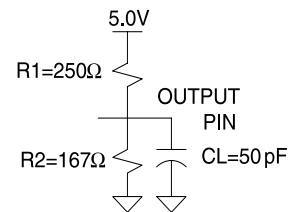

Functional Logic Diagram AT22LV10(L)

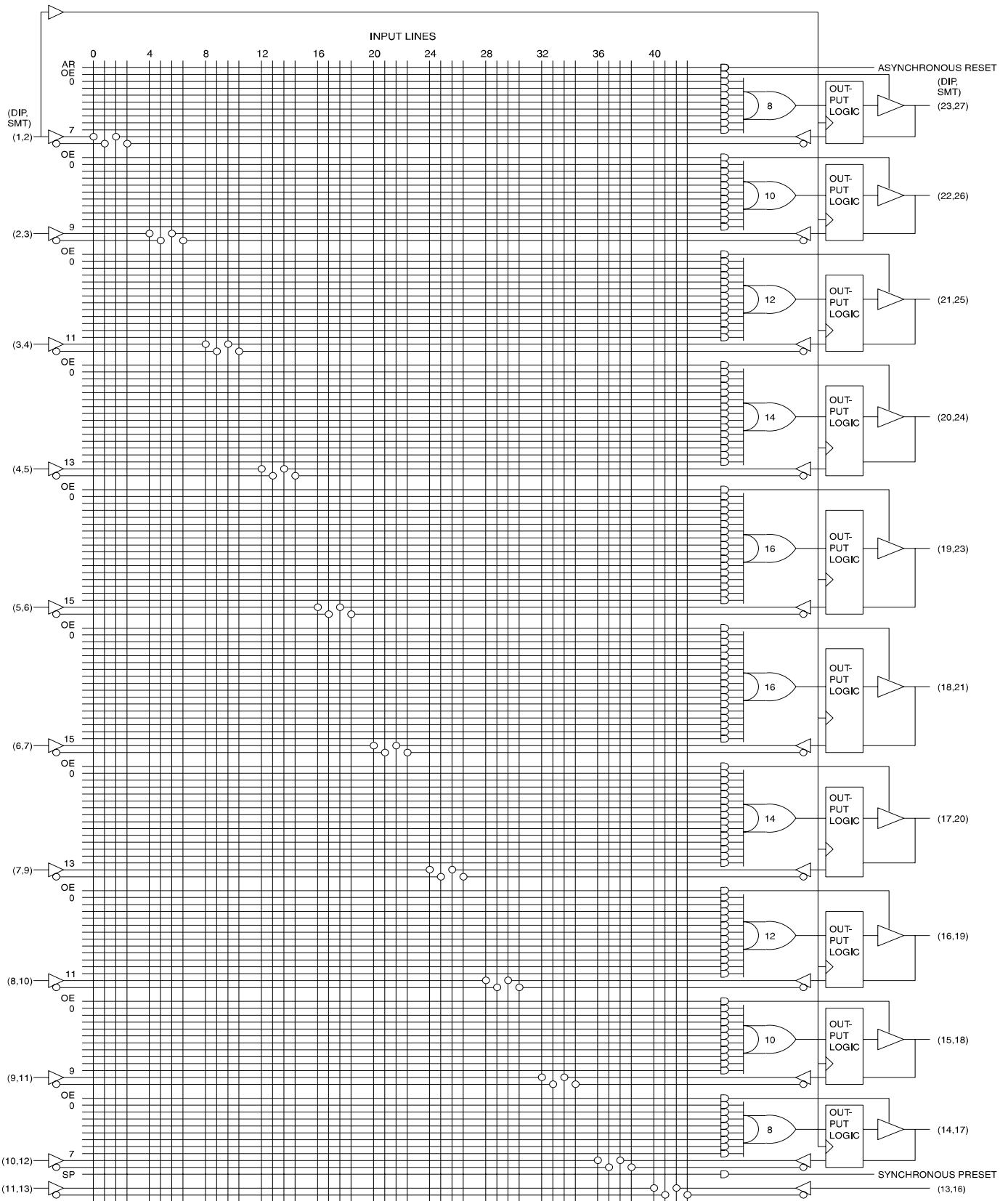

Preload of Registered Outputs

The registers in the AT22LV10 and AT22LV10L are provided with circuitry to allow loading of each register asynchronously with either a high or a low. This feature will simplify testing since any state can be forced into the registers to control test sequencing. A V_{IH} level on the I/O pin will force the register high; a V_{IL} will force it low, independent of the polarity bit (C0) setting. The preload state is entered by placing an 11.5V to 13V signal on pin 8 on

DIPs, and pin 10 on SMPs. When the clock pin is pulsed high, the data on the I/O pins is placed into the ten registers.

Level Forced on Registered Output Pin During Preload Cycle	Register State After Cycle
V_{IH}	High
V_{IL}	Low

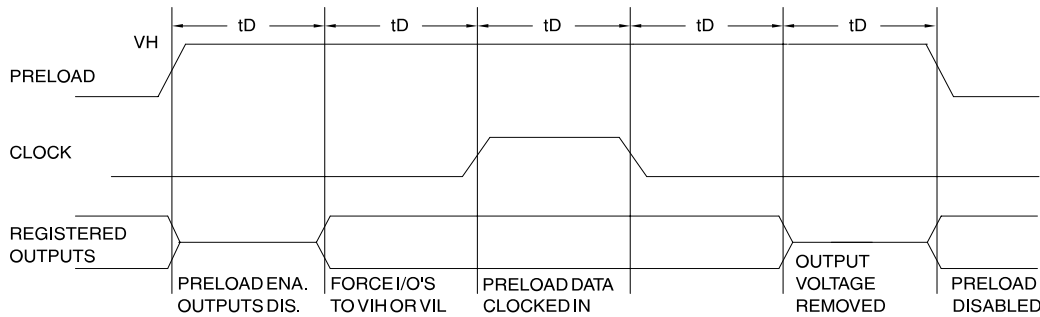

Power-up Reset

The registers in the AT22LV10 and AT22LV10L are designed to reset during power-up. At a point delayed slightly from V_{CC} crossing 2.5V, all registers will be reset to the low state. The output state will depend on the polarity of the output buffer.

This feature is critical for state machine initialization. However, due to the asynchronous nature of reset and the uncertainty of how V_{CC} actually rises in the system, the following conditions are required:

1. The V_{CC} rise must be monotonis;
2. After reset occurs, all input and feedback setup times must be met before driving the clock pin high, and
3. The clock must remain stable during t_{PR} .

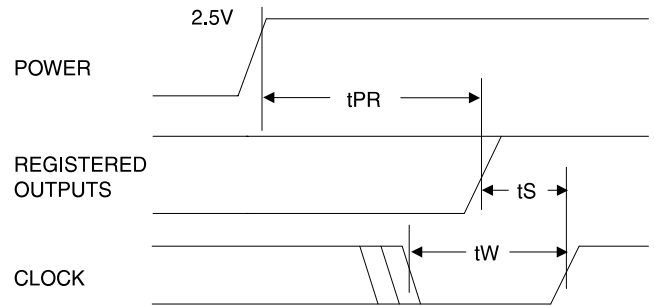

Parameter	Description	Min	Typ	Max	Units
t_{PR}	Power-up Reset Time		600	1000	ns

Pin Capacitance

($f = 1 \text{ MHz}$, $T = 25^\circ\text{C}$)⁽¹⁾

	Typ	Max	Units	Conditions
C_{IN}	5	8	pF	$V_{IN} = 0V$
C_{OUT}	6	8	pF	$V_{OUT} = 0V$

Note: 1. Typical values for nominal supply voltage. This parameter is only sampled and is not 100% tested.

Erasure Characteristics

The entire fuse array of an AT22LV10 or AT22LV10L is erased after exposure to ultraviolet light at a wavelength of 2537 Å. Complete erasure is assured after a minimum of 20 minutes exposure using 12,000 $\mu\text{W}/\text{cm}^2$ intensity lamps spaced one inch away from the chip. Minimum erase time for lamps at other intensity ratings can be calculated from

the minimum integrated erasure dose of 15 W-sec/cm². To prevent unintentional erasure, an opaque label is recommended to cover the clear window on any UV erasable PLD which will be subjected to continuous fluorescent indoor lighting or sunlight.

SUPPLY CURRENT vs. INPUT FREQUENCY

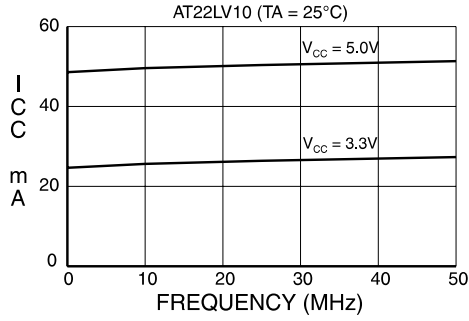

SUPPLY CURRENT vs. INPUT FREQUENCY

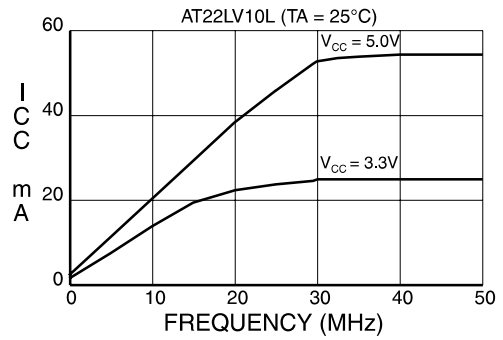

NORMALIZED SUPPLY CURRENT

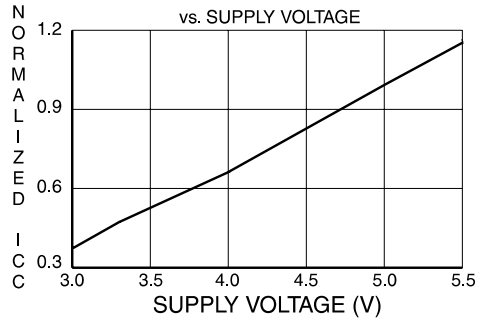

NORMALIZED ICC vs. AMBIENT TEMP.

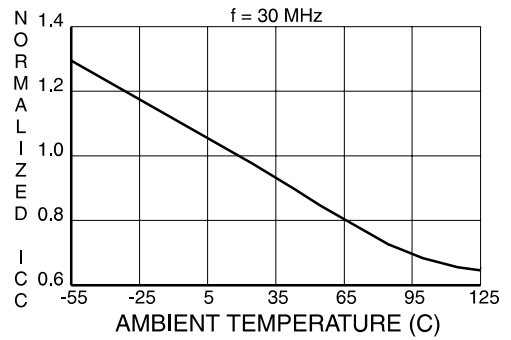

OUTPUT SINK CURRENT

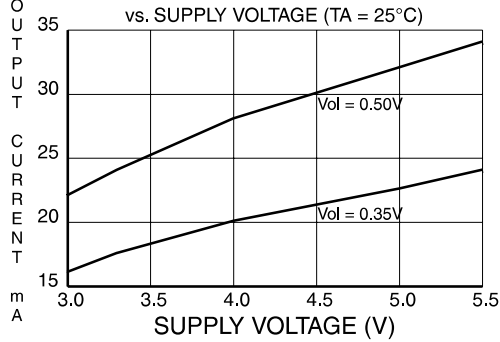

OUTPUT SINK CURRENT

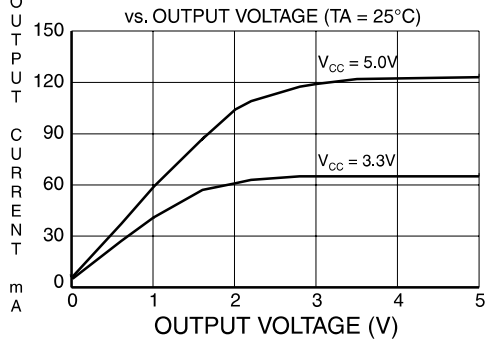

OUTPUT SOURCE CURRENT

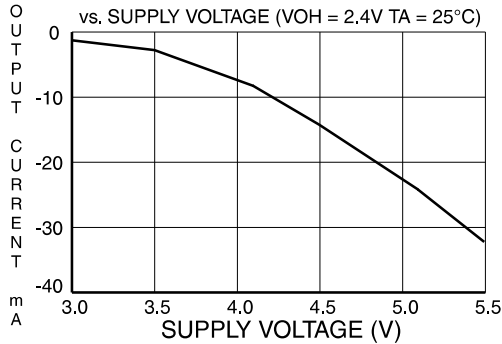

OUTPUT SOURCE CURRENT

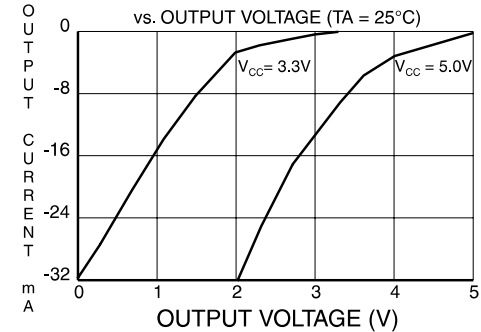

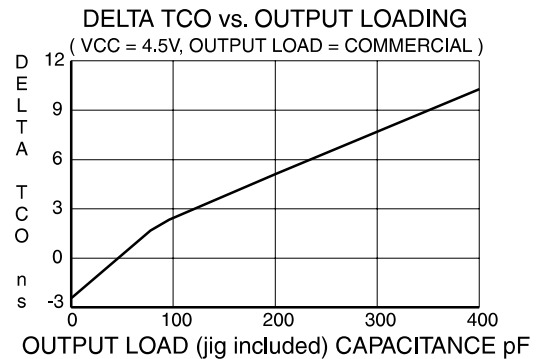
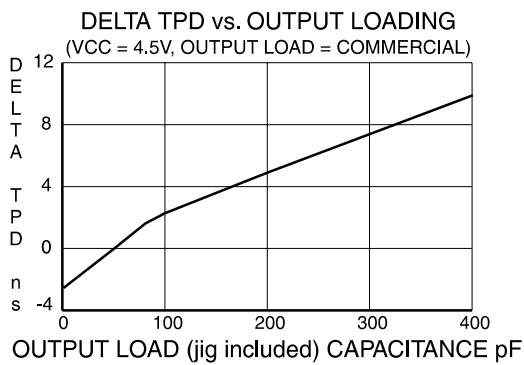
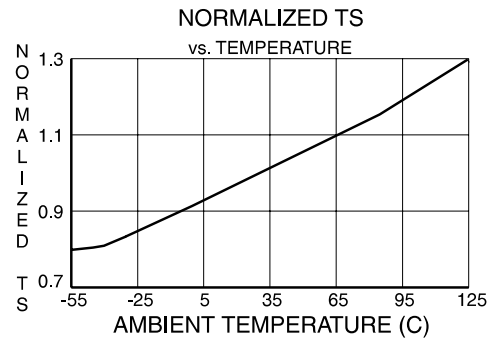
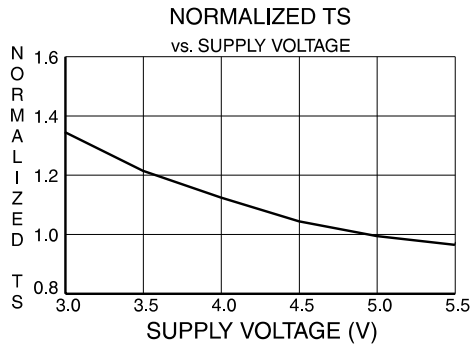
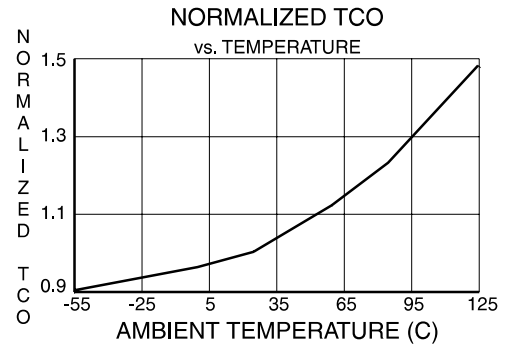
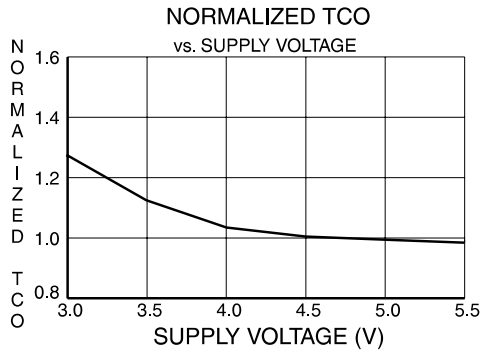
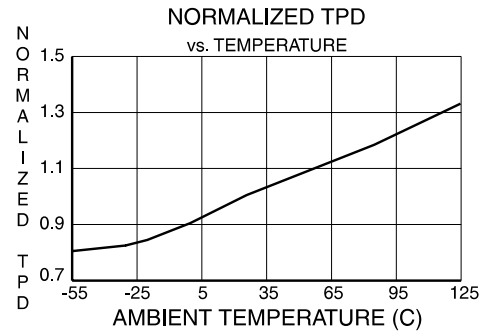
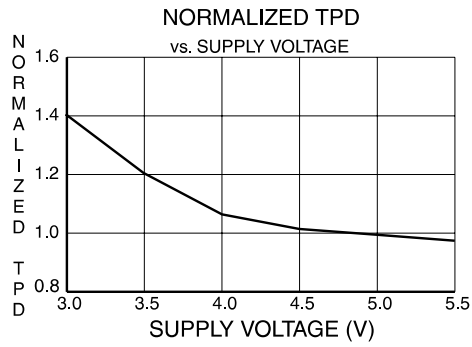



Ordering Information

t_{PD} (ns)	t_s (ns)	t_{CO} (ns)	Ordering Code	Package	Operation Range
20	10	14	AT22LV10-20JC AT22LV10-20PC AT22LV10-20SC	28J 24P3 24S	Commercial (0°C to 70°C)
			AT22LV10-20JI AT22LV10-20PI AT22LV10-20SI	28J 24P3 24S	Industrial (-40°C to 85°C)
25	12	17	AT22LV10-25JC AT22LV10-25PC AT22LV10-25SC	28J 24P3 24S	Commercial (0°C to 70°C)
			AT22LV10-25JI AT22LV10-25PI AT22LV10-25SI	28J 24P3 24S	Industrial (-40°C to 85°C)
25	17	14	AT22LV10L-25JC AT22LV10L-25PC AT22LV10L-25SC	28J 24P3 24S	Commercial (0°C to 70°C)
			AT22LV10L-25JI AT22LV10L-25PI AT22LV10L-25SI	28J 24P3 24S	Industrial (-40°C to 85°C)

Using “C” Product for Industrial

To use commercial product for Industrial temperature ranges, down-grade one speed grade from the “I” to the “C” device (7 ns “C” = 10 ns “I”) and de-rate power by 30%.

Package Type	
28J	28-lead, Plastic J-leaded Chip Carrier OTP (PLCC)
24P3	24-lead, 0.300" Wide, Plastic Dual Inline Package OTP (PDIP)
24S	24-lead, 0.300" Wide, Plastic Gull-Wing Small Outline OTP (SOIC)

Packaging Information

28J, 28-lead, Plastic J-leaded Chip Carrier (PLCC)
 Dimensions in Inches and (Millimeters)
 JEDEC STANDARD MS-018 AB

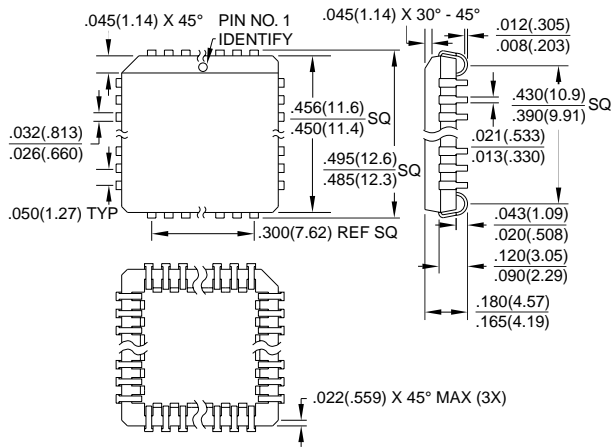

24P3, 24-lead, 0.300" Wide. Plastic
 Dual Inline Package (PDIP)
 Dimensions in Inches and (Millimeters)
 JEDEC STANDARD MS-011 AB

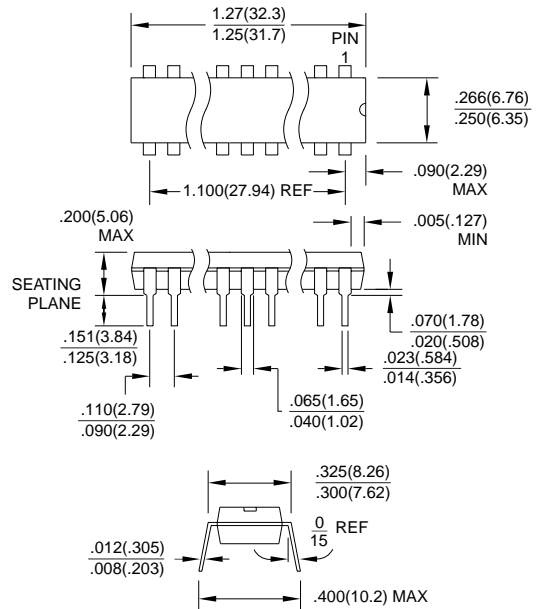

24S, 24-lead, 0.300" Wide, Plastic Gull-Wing Small
 Outline (SOIC)
 Dimensions in Inches and (Millimeters)

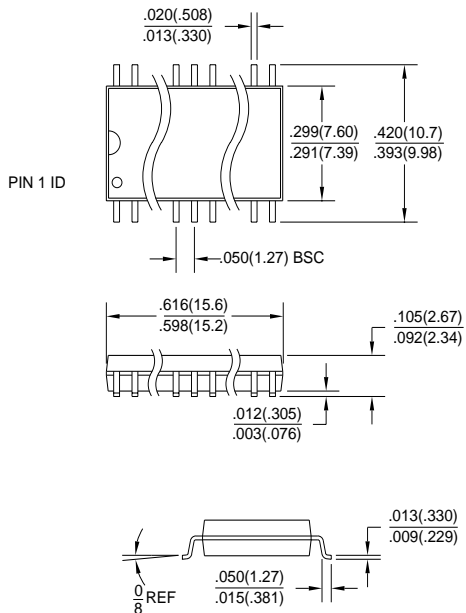



Atmel Headquarters

Corporate Headquarters

2325 Orchard Parkway
San Jose, CA 95131
TEL (408) 441-0311
FAX (408) 487-2600

Europe

Atmel U.K., Ltd.
Coliseum Business Centre
Riverside Way
Camberley, Surrey GU15 3YL
England
TEL (44) 1276-686-677
FAX (44) 1276-686-697

Asia

Atmel Asia, Ltd.
Room 1219
Chinachem Golden Plaza
77 Mody Road Tsimhatsui
East Kowloon
Hong Kong
TEL (852) 2721-9778
FAX (852) 2722-1369

Japan

Atmel Japan K.K.
9F, Tonetsu Shinkawa Bldg.
1-24-8 Shinkawa
Chuo-ku, Tokyo 104-0033
Japan
TEL (81) 3-3523-3551
FAX (81) 3-3523-7581

Atmel Operations

Atmel Colorado Springs

1150 E. Cheyenne Mtn. Blvd.
Colorado Springs, CO 80906
TEL (719) 576-3300
FAX (719) 540-1759

Atmel Rousset

Zone Industrielle
13106 Rousset Cedex
France
TEL (33) 4-4253-6000
FAX (33) 4-4253-6001

Fax-on-Demand

North America:
1-(800) 292-8635
International:
1-(408) 441-0732

e-mail

literature@atmel.com

Web Site

<http://www.atmel.com>

BBS

1-(408) 436-4309

© Atmel Corporation 1999.

Atmel Corporation makes no warranty for the use of its products, other than those expressly contained in the Company's standard warranty which is detailed in Atmel's Terms and Conditions located on the Company's web site. The Company assumes no responsibility for any errors which may appear in this document, reserves the right to change devices or specifications detailed herein at any time without notice, and does not make any commitment to update the information contained herein. No licenses to patents or other intellectual property of Atmel are granted by the Company in connection with the sale of Atmel products, expressly or by implication. Atmel's products are not authorized for use as critical components in life support devices or systems.

Marks bearing ® and/or ™ are registered trademarks and trademarks of Atmel Corporation.

Terms and product names in this document may be trademarks of others.



Printed on recycled paper.

0190E-08/99/xM