



Welcome to E-XFL.COM

Understanding Embedded - PLDs (Programmable Logic Devices)

Embedded - PLDs, or Programmable Logic Devices, are a type of digital electronic component used to build reconfigurable digital circuits. Unlike fixed-function logic devices, PLDs can be programmed to perform specific functions by the user. This flexibility allows designers to customize the logic to meet the exact needs of their applications, making PLDs a crucial component in modern embedded systems.

Applications of Embedded - PLDs (Programmable Logic Devices)

The versatility of PLDs makes them suitable for a wide range of applications. In consumer electronics, PLDs are used to enhance the functionality and performance of

Details

Product Status	Obsolete
Programmable Type	EE PLD
Number of Macrocells	8
Voltage - Input	5V
Speed	15 ns
Mounting Type	Surface Mount
Package / Case	20-SOIC (0.295", 7.50mm Width)
Supplier Device Package	20-SOIC
Purchase URL	https://www.e-xfl.com/product-detail/microchip-technology/atf16v8cz-15sc

Figure 1-1. Block Diagram

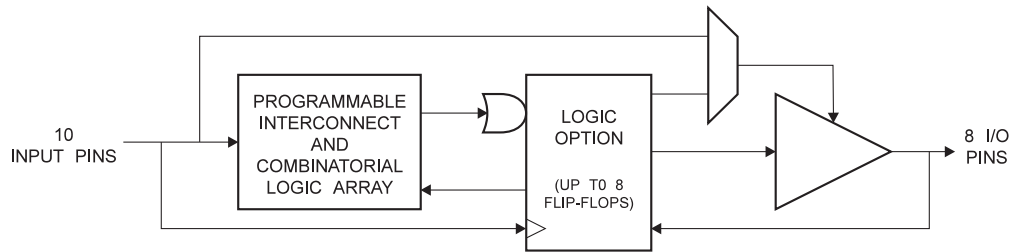

2. Pin Configuration and Pinouts

Table 2-1. Pinouts - All Pinouts Top View

Pin Name	Function
CLK	Clock
I	Logic Inputs
I/O	Bi-directional Buffers
\overline{OE}	Output Enable
VCC	+5V Supply

Figure 2-1. TSSOP

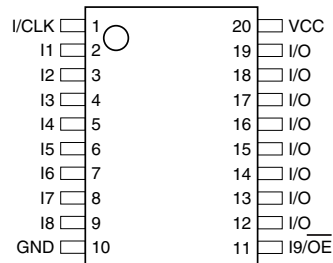

Figure 2-2. DIP/SOIC

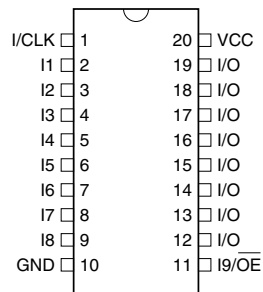
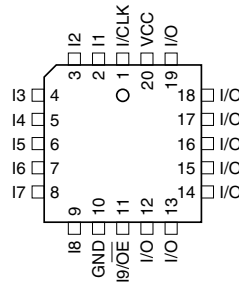

Figure 2-3. PLCC



3. Absolute Maximum Ratings*

Temperature Under Bias.....	-40°C to +85°C
Storage Temperature	-65°C to +150°C
Voltage on Any Pin with Respect to Ground	-2.0V to +7.0V ⁽¹⁾
Voltage on Input Pins with Respect to Ground During Programming.....	-2.0V to +14.0V ⁽¹⁾
Programming Voltage with Respect to Ground	-2.0V to +14.0V ⁽¹⁾

***NOTICE:** Stresses beyond those listed under “Absolute Maximum Ratings” may cause permanent damage to the device. This is a stress rating only and functional operation of the device at these or any other conditions beyond those indicated in the operational sections of this specification is not implied. Exposure to absolute maximum rating conditions for extended periods may affect device reliability.

Note: 1. Minimum voltage is -0.6V DC, which may undershoot to -2.0V for pulses of less than 20 ns. Maximum output pin voltage is $V_{CC} + 0.75V$ DC, which may overshoot to 7.0V for pulses of less than 20 ns.

4. DC and AC Operating Conditions

	Commercial	Industrial
Operating Temperature (Ambient)	0°C - 70°C	-40°C - 85°C
V_{CC} Power Supply	5V ±5%	5V ±10%

4.1 DC Characteristics

Symbol	Parameter	Condition	Min	Typ	Max	Units
I_{IL}	Input or I/O Low Leakage Current	$0 \leq V_{IN} \leq V_{IL}(\text{Max})$			-10	μA
I_{IH}	Input or I/O High Leakage Current	$3.5 \leq V_{IN} \leq V_{CC}$			10	μA
I_{CC1}	Power Supply Current	15 MHz, $V_{CC} = \text{Max}$, $V_{IN} = 0$, V_{CC} , Outputs Open	Com		95	mA
			Ind.		105	mA
$I_{CC}^{(1)}$	Power Supply Current, Standby Mode	0 MHz, $V_{CC} = \text{Max}$, $V_{IN} = 0$, V_{CC} , Outputs Open	Com.	5		μA
			Ind	5		μA
I_{OS}	Output Short Circuit Current	$V_{OUT} = 0.5V$; $V_{CC} = 5V$; $TA = 25^\circ C$			-150	mA
V_{IL}	Input Low Voltage	$\text{Min} < V_{CC} < \text{Max}$	-0.5		0.8	V
V_{IH}	Input High Voltage		2.0		$V_{CC}+1$	V
V_{OL}	Output Low Voltage	$V_{CC} = \text{Min}$, All Outputs $I_{OL} = -16 \text{ mA}$			0.5	V

4.1 DC Characteristics

Symbol	Parameter	Condition	Min	Typ	Max	Units
V_{OH}	Output High Voltage	$V_{CC} = \text{Min}$ $I_{OL} = -3.2 \text{ mA}$	2.4			V
I_{OL}	Output Low Current	$V_{CC} = \text{Min}$	Com.	24		mA
			Ind.	12		
I_{OH}	Output High Current	$V_{CC} = \text{Min}$	Com., Ind.	4		mA

Note: 1. All I_{CC} parameters measured with outputs open. Data is based on Atmel test patterns. Reading may vary with pattern.

4.2 AC Waveforms⁽¹⁾

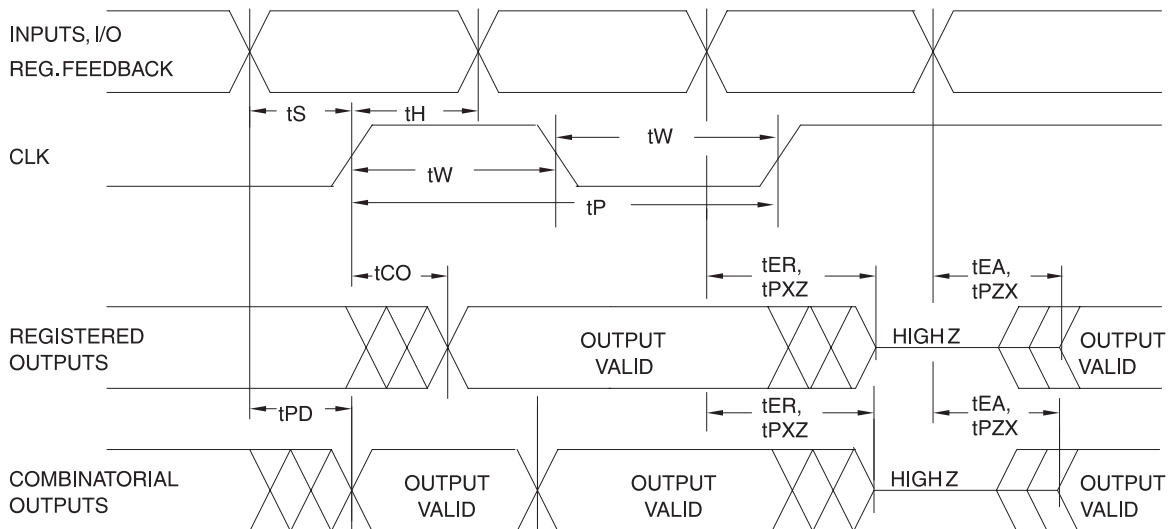

Note: 1. Timing measurement reference is 1.5V. Input AC driving levels are 0.0V and 3.0V, unless otherwise specified.

4.3 AC Characteristics

Symbol	Parameter	-12		-15		Units
		Min	Max	Min	Max	
t_{PD}	Input or Feedback to Non-registered Output	3	12	3	15	ns
t_{CF}	Clock to Feedback		6		8	ns
t_{CO}	Clock to Output	2	8	2	10	ns
t_S	Input or Feedback Setup Time	10		12		ns
t_H	Input Hold Time	0		0		ns
t_P	Clock Period	12		16		ns
t_W	Clock Width	6		8		ns
f_{MAX}	External Feedback $1/(t_S + t_{CO})$		55		45	MHz
	Internal Feedback $1/(t_S + t_{CF})$		62		50	MHz
	No Feedback $1/(t_P)$		83		62	MHz
t_{EA}	Input to Output Enable – Product Term	3	12	3	15	ns
t_{ER}	Input to Output Disable – Product Term	2	15	2	15	ns
t_{PZX}	\overline{OE} pin to Output Enable	2	12	2	15	ns
t_{PXZ}	\overline{OE} pin to Output Disable	1.5	12	1.5	15	ns

4.4 Input Test Waveforms

4.4.1 Input Test Waveforms and Measurement Levels

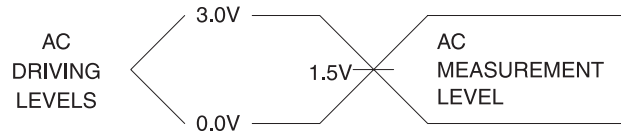

$$t_R, t_F < 1.5 \text{ ns (10% to 90%)}$$

4.4.2 Output Test Loads

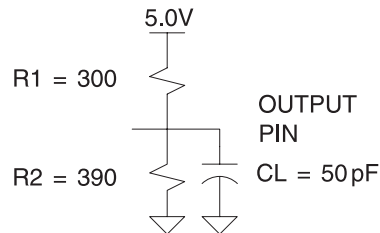

Note: Similar devices are tested with slightly different loads. These load differences may affect output signals' delay and slew rate. Atmel devices are tested with sufficient margins to meet compatible devices.

4.4.3 Pin Capacitance

Table 4-1. Pin Capacitance (f = 1 MHz, T = 25°C⁽¹⁾)

	Typ	Max	Units	Conditions
C _{IN}	5	8	pF	V _{IN} = 0V
C _{OUT}	6	8	pF	V _{OUT} = 0V

Note: 1. Typical values for nominal supply voltage. This parameter is only sampled and is not 100% tested.

4.5 Power-up Reset

The ATF16V8CZ's registers are designed to reset during power-up. At a point delayed slightly from V_{CC} crossing V_{RST} , all registers will be reset to the low state. As a result, the registered output state will always be high on power-up.

This feature is critical for state machine initialization. However, due to the asynchronous nature of reset and the uncertainty of how V_{CC} actually rises in the system, the following conditions are required:

1. The V_{CC} rise must be monotonic, from below 0.7V,
2. After reset occurs, all input and feedback setup times must be met before driving the clock term high, and
3. The signals from which the clock is derived must remain stable during t_{PR} .

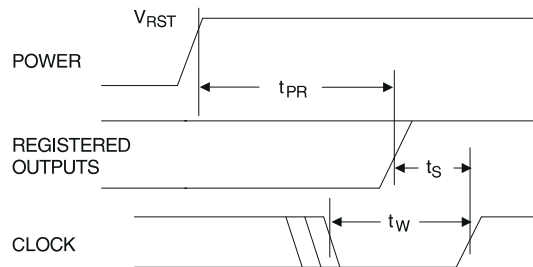

Parameter	Description	Typ	Max	Units
t_{PR}	Power-up Reset Time	600	1,000	ns
V_{RST}	Power-up Reset Voltage	3.8	4.5	V

4.6 Preload of Registered Outputs

The ATF16V8CZ's registers are provided with circuitry to allow loading of each register with either a high or a low. This feature will simplify testing since any state can be forced into the registers to control test sequencing. A JEDEC file with preload is generated when a source file with vectors is compiled. Once downloaded, the JEDEC file preload sequence will be done automatically by approved programmers.

5. Security Fuse Usage

A single fuse is provided to prevent unauthorized copying of the ATF16V8CZ fuse patterns. Once programmed, fuse verify and preload are inhibited. However, the 64-bit User Signature remains accessible.

The security fuse should be programmed last, as its effect is immediate.

6. Input and I/O Pin-keeper Circuits

The ATF16V8CZ contains internal input and I/O pin-keeper circuits. These circuits allow each ATF16V8CZ pin to hold its previous value even when it is not being driven by an external source or by the device's output buffer. This helps insure that all logic array inputs are at known, valid logic levels. This reduces system power by preventing pins from floating to indeterminate levels. By using pin-keeper circuits rather than pull-up resistors, there is no DC current required to hold the pins in either logic state (high or low).

These pin-keeper circuits are implemented as weak feedback inverters, as shown in the Input Diagram below. These keeper circuits can easily be overdriven by standard TTL- or CMOS-compatible drivers. The typical overdrive current required is 40 μA .

Figure 6-1. Input Diagram

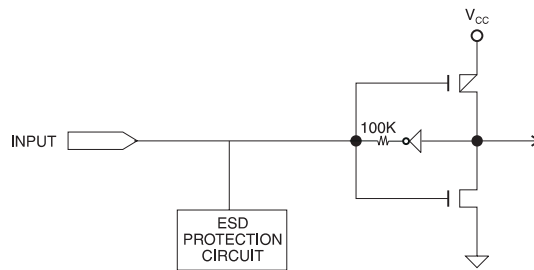
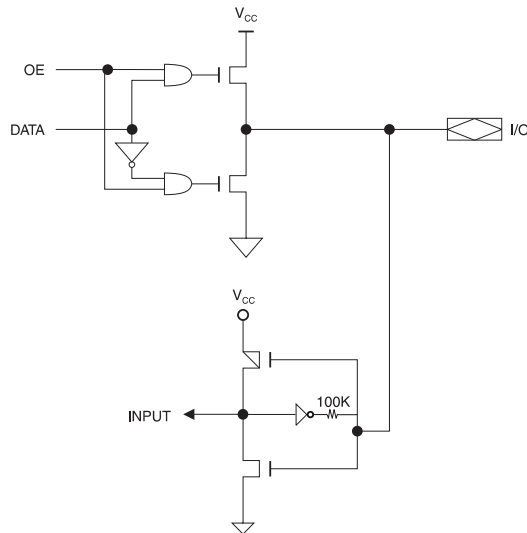

Figure 6-2. I/O Diagram



7. Functional Logic Diagram Description

The Logic Option and Functional Diagrams describe the ATF16V8CZ architecture. Eight configurable macrocells can be configured as a registered output, combinatorial I/O, combinatorial output, or dedicated input.

The ATF16V8CZ can be configured in one of three different modes. Each mode makes the ATF16V8CZ look like a different device. Most PLD compilers can choose the right mode automatically. The user can also force the selection by supplying the compiler with a mode selection. The determining factors would be the usage of register versus combinatorial outputs and dedicated outputs versus outputs with output enable control.

The ATF16V8CZ universal architecture can be programmed to emulate many 20-pin PAL devices. These architectural subsets can be found in each of the configuration modes described in the following pages. The user can download the listed subset device JEDEC programming file to the PLD programmer, and the ATF16V8CZ can be configured to act like the chosen device. Check with your programmer manufacturer for this capability.

Unused product terms are automatically disabled by the compiler to decrease power consumption. A security fuse, when programmed, protects the content of the ATF16V8CZ. Eight bytes (64 fuses) of User Signature are accessible to the user for purposes such as storing project name, part number, revision, or date. The User Signature is accessible regardless of the state of the security fuse.

Table 7-1. Compiler Mode Selection

	Registered	Complex	Simple	Auto Select
ABEL, Atmel-ABEL	P16C8R	P16V8C	P16V8AS	P16V8
CUPL	G16V8MS	G16V8MA	G16V8AS	G16V8A
LOG/iC	GAL16V8_R ⁽¹⁾	GAL16V8_C7 ⁽¹⁾	GAL16V8_C8 ⁽¹⁾	GAL16V8
OrCAD-PLD	“Registered”	“Complex”	“Simple”	GAL16V8A
PLDesigner	P16V8R	P16V8C	P16V8C	P16V8A
Tango-PLD	G16V8R	G16V8C	G16V8AS	G16V8

Notes: 1. Only applicable for version 3.4 or lower.

Figure 8-3. Registered Mode Logic Diagram

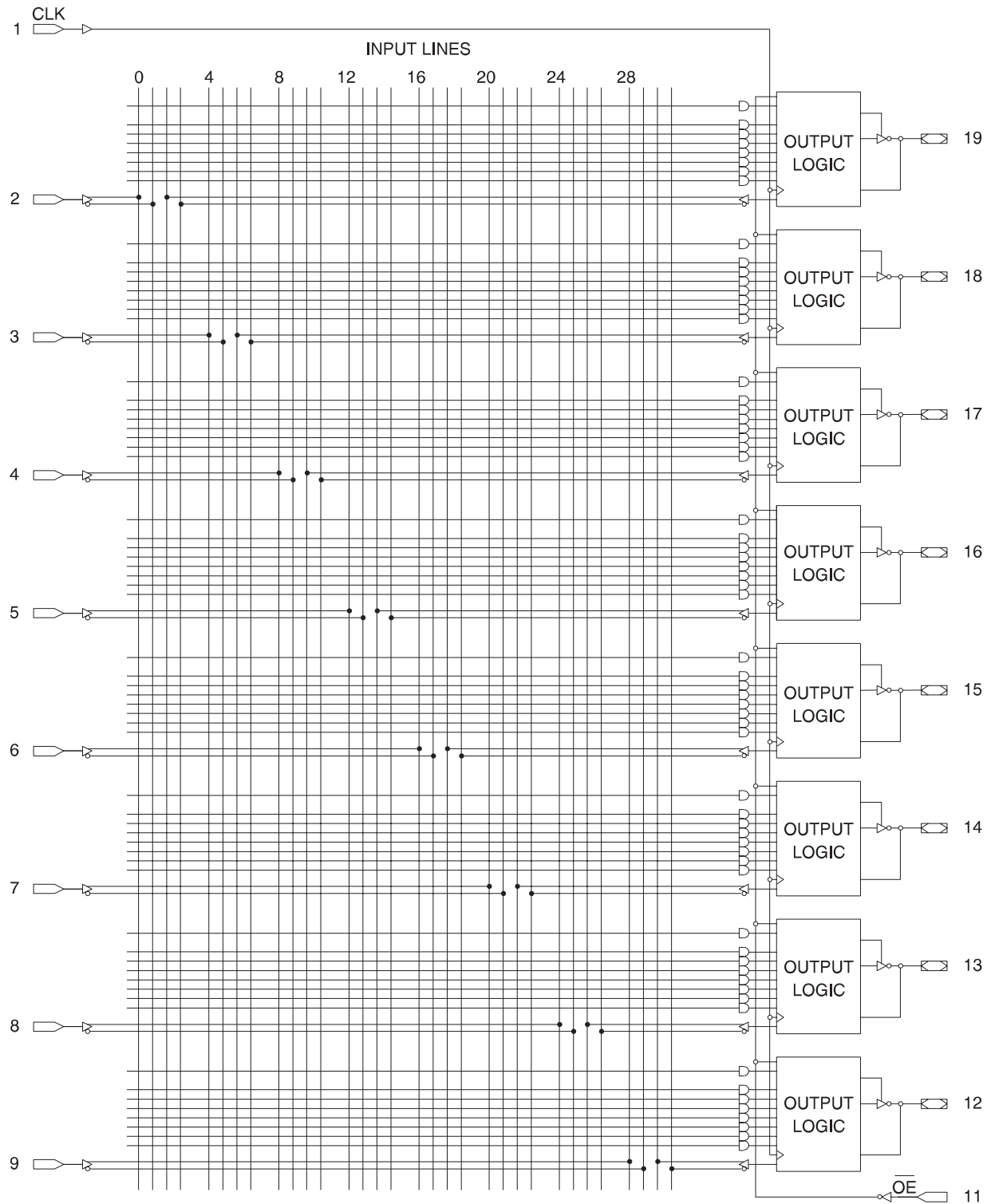

8.2 ATF16V8CZ Complex Mode

PAL Device Emulation/PAL Replacement. In the complex mode, combinatorial output and I/O functions are possible. Pins 1 and 11 are regular inputs to the array. Pins 13 through 18 have pin feedback paths back to the AND-array, which makes full I/O capability possible. Pins 12 and 19 (outermost macrocells) are outputs only. They do not have input capability. In this mode, each macrocell has seven product terms going to the sum term and one product term enabling the output.

Combinatorial applications with an \overline{OE} requirement will make the compiler select this mode. The following devices can be emulated using this mode:

16L8

16H8

16P8

Figure 8-4. Complex Mode Option

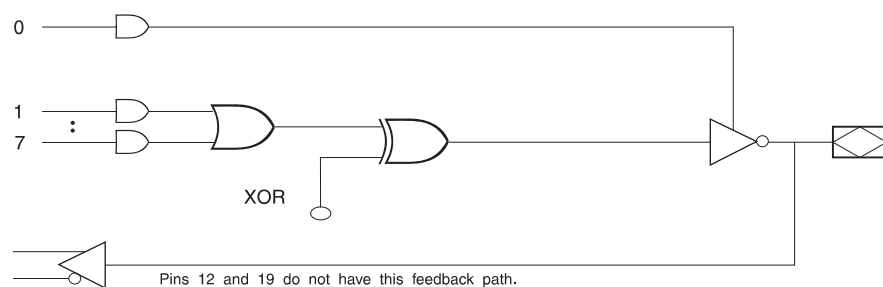

9. ATF16V8CZ Simple Mode

PAL Device Emulation/PAL Replacement. In the Simple Mode, 8 product terms are allocated to the sum term. Pins 15 and 16 (center macrocells) are permanently configured as combinatorial outputs. Other macrocells can be either inputs or combinatorial outputs with pin feedback to the AND-array. Pins 1 and 11 are regular inputs.

The compiler selects this mode when all outputs are combinatorial without \overline{OE} control. The following simple PALs can be emulated using this mode:

10L8 10H8 10P8

12L6 12H6 12P6

14L4 14H4 14P4

16L2 16H2 16P2

Figure 9-1. Simple Mode Option

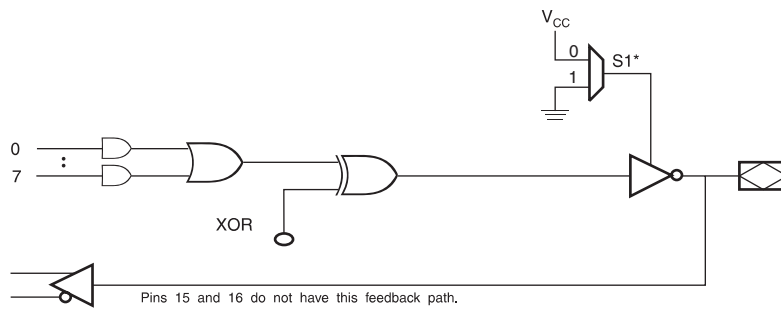

* - Pins 15 and 16 are always enabled.

Figure 9-2. Complex Mode Logic Diagram

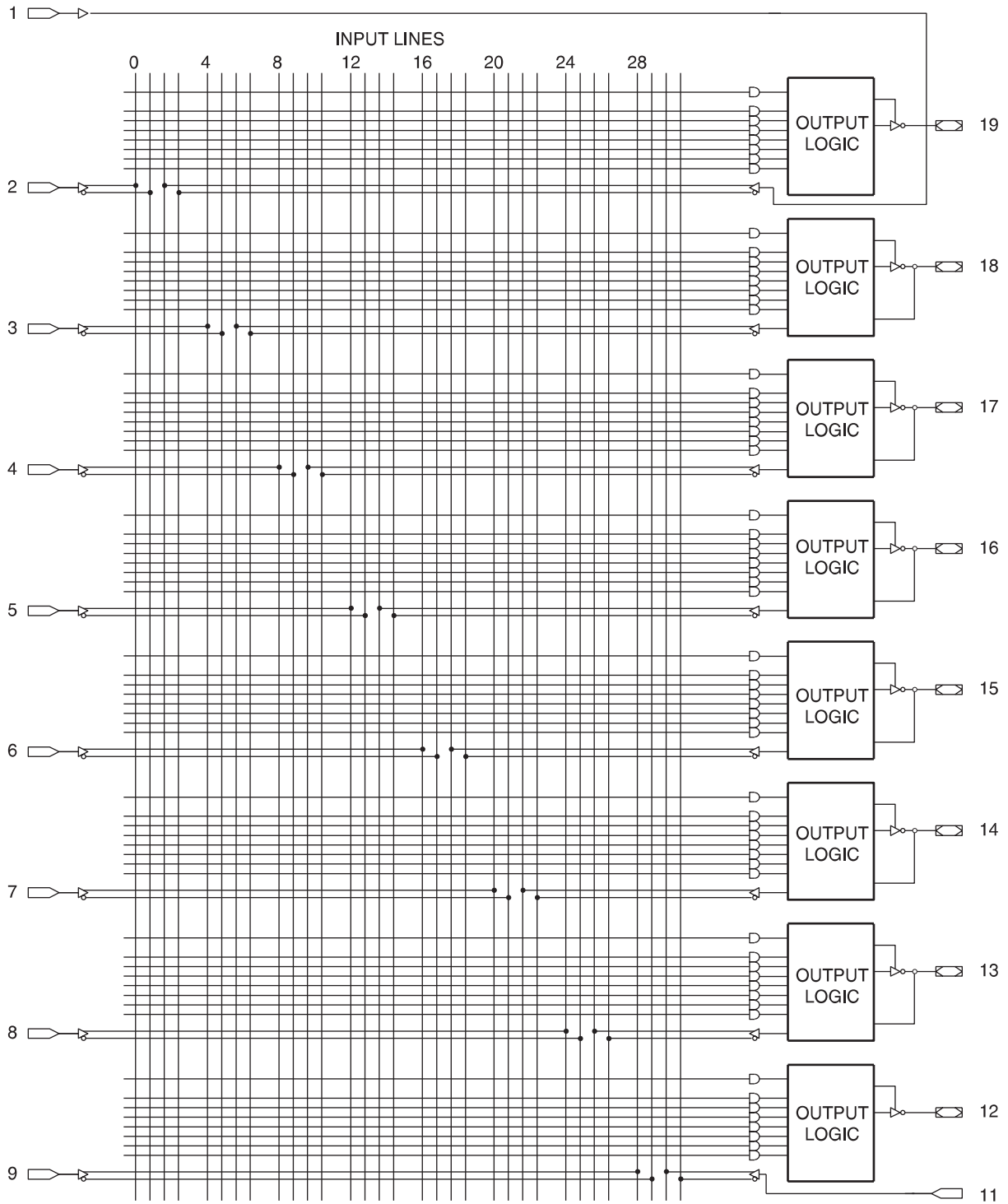
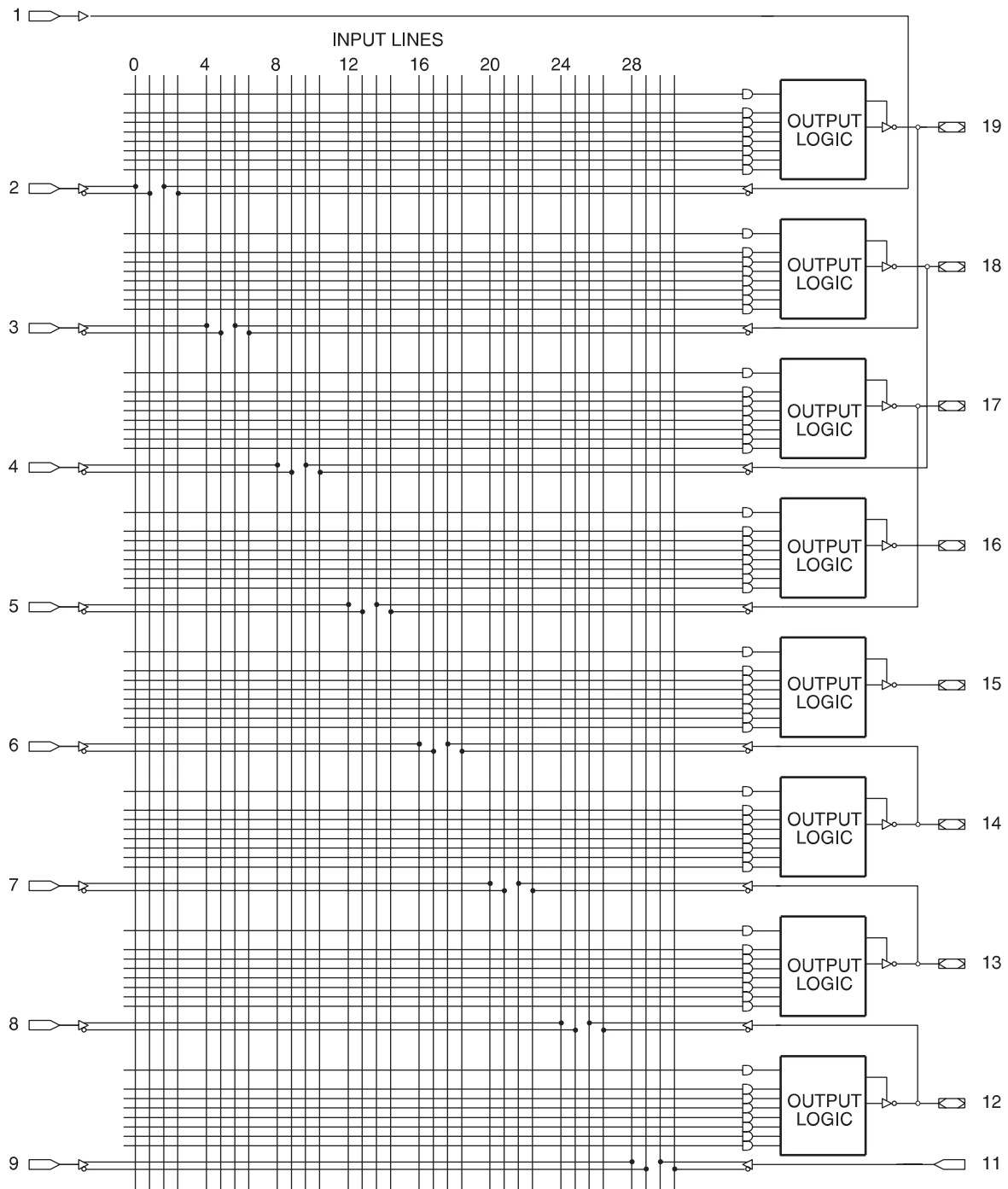
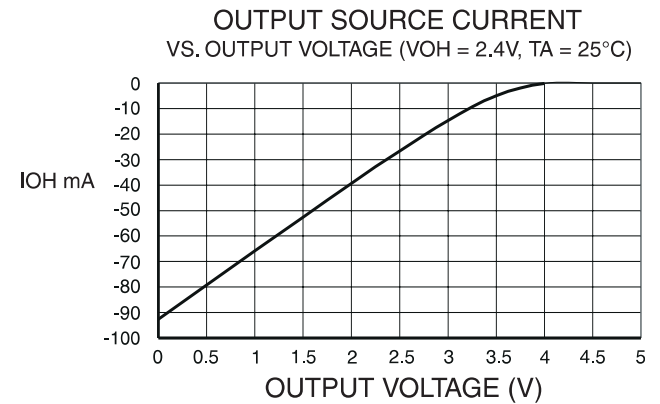
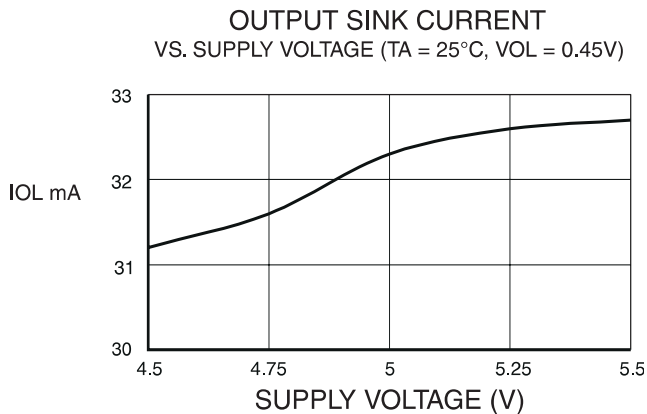
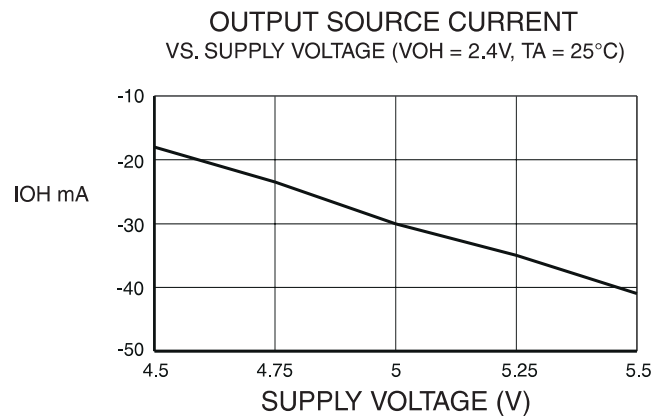
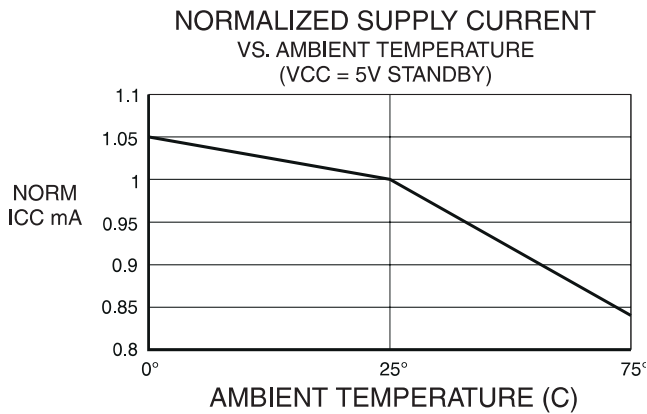
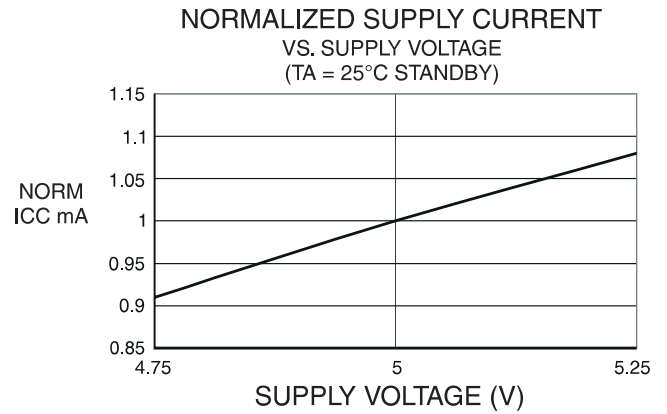
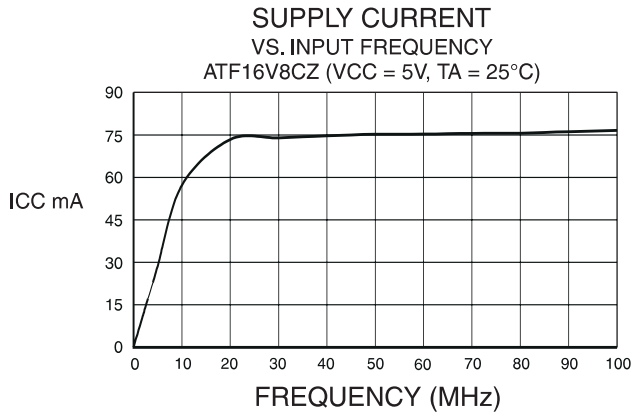

Figure 9-3. Simple Mode Logic Diagram



9.1 Test Characterization Data



11. Package Information

11.1 20J – PLCC

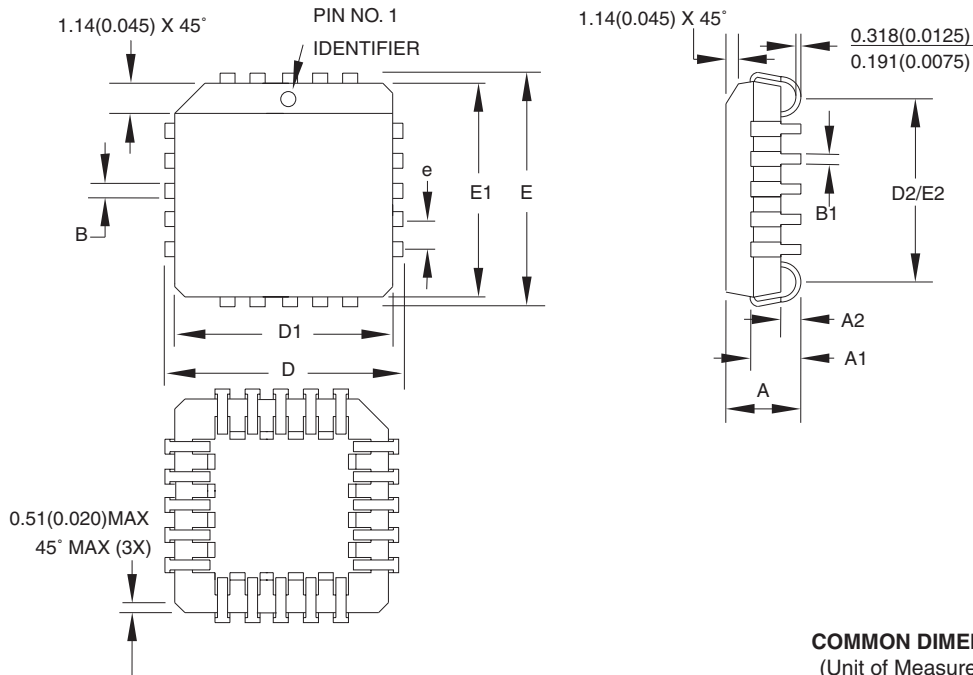

COMMON DIMENSIONS
(Unit of Measure = mm)

SYMBOL	MIN	NOM	MAX	NOTE
A	4.191	-	4.572	
A1	2.286	-	3.048	
A2	0.508	-	-	
D	9.779	-	10.033	
D1	8.890	-	9.042	Note 2
E	9.779	-	10.033	
E1	8.890	-	9.042	Note 2
D2/E2	7.366	-	8.382	
B	0.660	-	0.813	
B1	0.330	-	0.533	
e	1.270 TYP			

- Notes:
1. This package conforms to JEDEC reference MS-018, Variation AA.
 2. Dimensions D1 and E1 do not include mold protrusion. Allowable protrusion is .010"(0.254 mm) per side. Dimension D1 and E1 include mold mismatch and are measured at the extreme material condition at the upper or lower parting line.
 3. Lead coplanarity is 0.004" (0.102 mm) maximum.

10/04/01



2325 Orchard Parkway
San Jose, CA 95131

TITLE

20J, 20-lead, Plastic J-leaded Chip Carrier (PLCC)

DRAWING NO.

20J

REV.

B



11.2 20P3 – PDIP

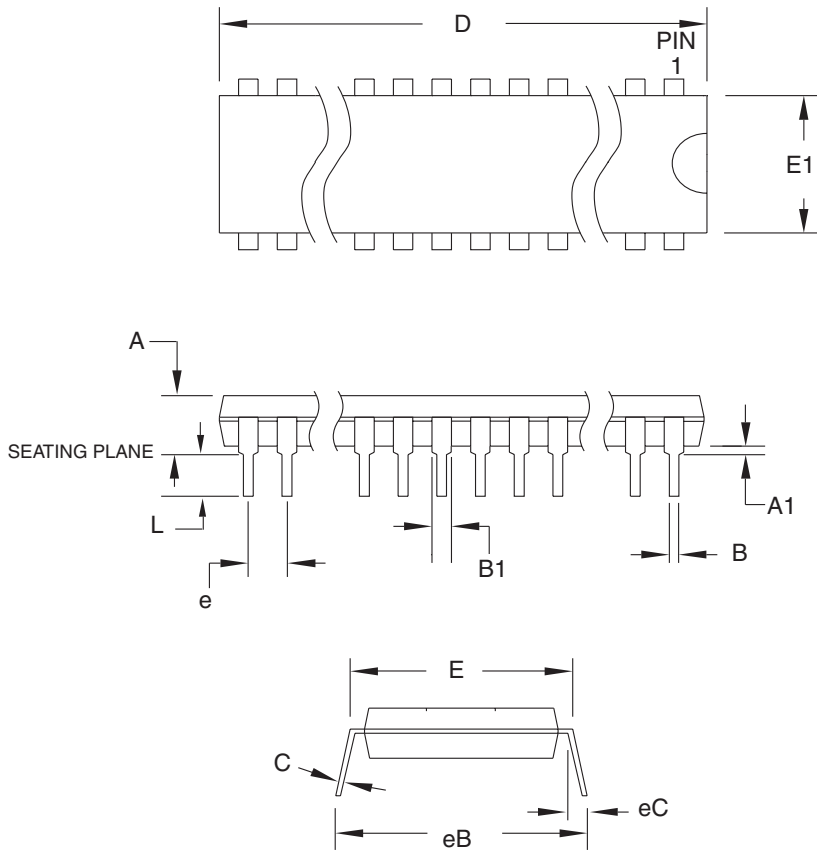

COMMON DIMENSIONS
(Unit of Measure = mm)

SYMBOL	MIN	NOM	MAX	NOTE
A	–	–	5.334	
A1	0.381	–	–	
D	24.892	–	26.924	Note 2
E	7.620	–	8.255	
E1	6.096	–	7.112	Note 2
B	0.356	–	0.559	
B1	1.270	–	1.551	
L	2.921	–	3.810	
C	0.203	–	0.356	
eB	–	–	10.922	
eC	0.000	–	1.524	
e	2.540 TYP			

- Notes:
1. This package conforms to JEDEC reference MS-001, Variation AD.
 2. Dimensions D and E1 do not include mold Flash or Protrusion. Mold Flash or Protrusion shall not exceed 0.25 mm (0.010").

1/23/04



2325 Orchard Parkway
San Jose, CA 95131

TITLE

20P3, 20-lead (0.300"/7.62 mm Wide) Plastic Dual
Inline Package (PDIP)

DRAWING NO.

20P3

REV.

D

11.3 20S – SOIC

Dimensions in Millimeters and (Inches).
 Controlling dimension: Inches.
 JEDEC Standard MS-013

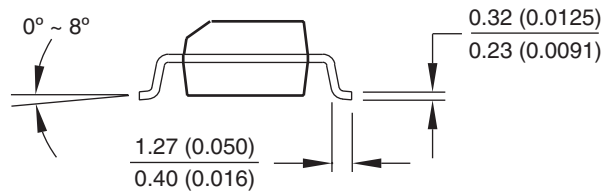
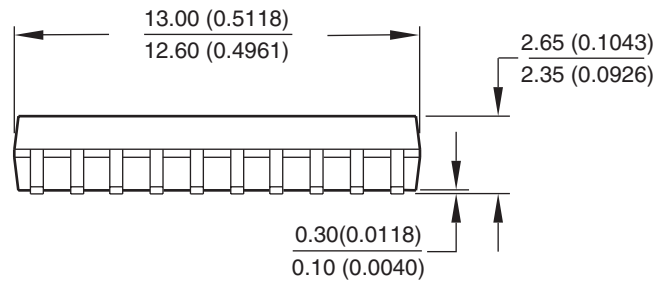
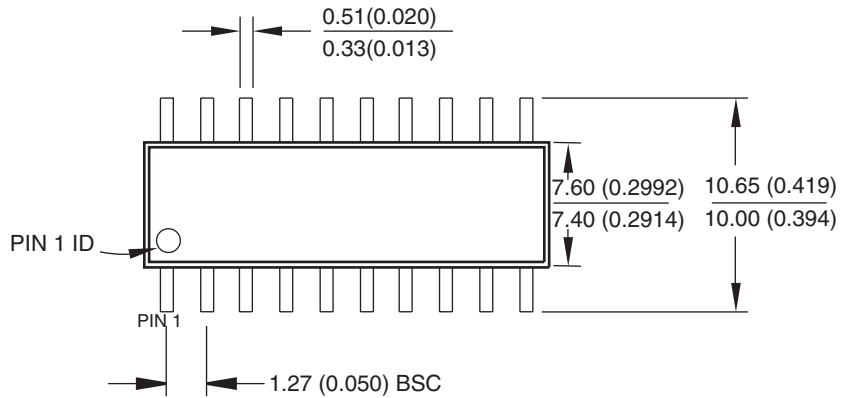

10/23/03



2325 Orchard Parkway
 San Jose, CA 95131

TITLE

20S, 20-lead, 0.300" Body, Plastic Gull Wing Small Outline (SOIC)

DRAWING NO.

20S

REV.

B



11.4 20X – TSSOP

Dimensions in Millimeters and (Inches).
 Controlling dimension: Millimeters.
 JEDEC Standard MO-153 AC

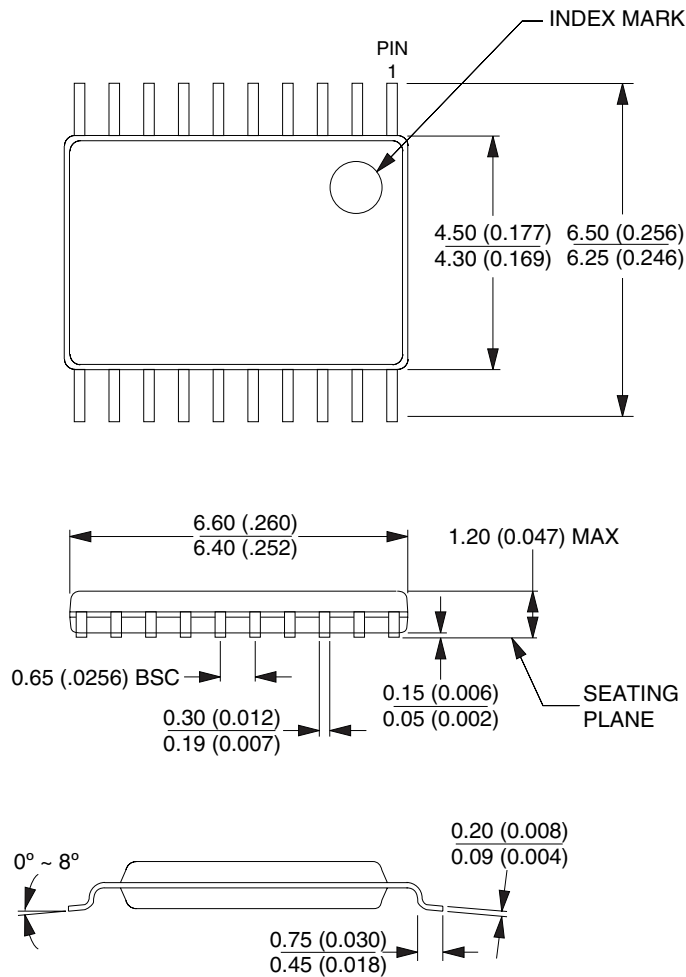

10/23/03



2325 Orchard Parkway
 San Jose, CA 95131

TITLE

20X, (Formerly 20T), 20-lead, 4.4 mm Body Width,
 Plastic Thin Shrink Small Outline Package (TSSOP)

DRAWING NO.

20X

REV.

C

12. Revision History

12.1 0453H

1. Green Package options added in 2005.



Atmel Corporation

2325 Orchard Parkway
San Jose, CA 95131, USA
Tel: 1(408) 441-0311
Fax: 1(408) 487-2600

Regional Headquarters

Europe

Atmel Sarl
Route des Arsenalux 41
Case Postale 80
CH-1705 Fribourg
Switzerland
Tel: (41) 26-426-5555
Fax: (41) 26-426-5500

Asia

Room 1219
Chinachem Golden Plaza
77 Mody Road Tsimshatsui
East Kowloon
Hong Kong
Tel: (852) 2721-9778
Fax: (852) 2722-1369

Japan

9F, Tonetsu Shinkawa Bldg.
1-24-8 Shinkawa
Chuo-ku, Tokyo 104-0033
Japan
Tel: (81) 3-3523-3551
Fax: (81) 3-3523-7581

Atmel Operations

Memory

2325 Orchard Parkway
San Jose, CA 95131, USA
Tel: 1(408) 441-0311
Fax: 1(408) 436-4314

Microcontrollers

2325 Orchard Parkway
San Jose, CA 95131, USA
Tel: 1(408) 441-0311
Fax: 1(408) 436-4314

La Chantrerie
BP 70602
44306 Nantes Cedex 3, France
Tel: (33) 2-40-18-18-18
Fax: (33) 2-40-18-19-60

ASIC/ASSP/Smart Cards

Zone Industrielle
13106 Rousset Cedex, France
Tel: (33) 4-42-53-60-00
Fax: (33) 4-42-53-60-01

1150 East Cheyenne Mtn. Blvd.
Colorado Springs, CO 80906, USA
Tel: 1(719) 576-3300
Fax: 1(719) 540-1759

Scottish Enterprise Technology Park
Maxwell Building
East Kilbride G75 0QR, Scotland
Tel: (44) 1355-803-000
Fax: (44) 1355-242-743

RF/Automotive

Theresienstrasse 2
Postfach 3535
74025 Heilbronn, Germany
Tel: (49) 71-31-67-0
Fax: (49) 71-31-67-2340

1150 East Cheyenne Mtn. Blvd.
Colorado Springs, CO 80906, USA
Tel: 1(719) 576-3300
Fax: 1(719) 540-1759

Biometrics/Imaging/Hi-Rel MPU/ High Speed Converters/RF Datacom

Avenue de Rochepleine
BP 123
38521 Saint-Egreve Cedex, France
Tel: (33) 4-76-58-30-00
Fax: (33) 4-76-58-34-80

Literature Requests

www.atmel.com/literature

Disclaimer: The information in this document is provided in connection with Atmel products. No license, express or implied, by estoppel or otherwise, to any intellectual property right is granted by this document or in connection with the sale of Atmel products. **EXCEPT AS SET FORTH IN ATMEL'S TERMS AND CONDITIONS OF SALE LOCATED ON ATMEL'S WEB SITE, ATMEL ASSUMES NO LIABILITY WHATSOEVER AND DISCLAIMS ANY EXPRESS, IMPLIED OR STATUTORY WARRANTY RELATING TO ITS PRODUCTS INCLUDING, BUT NOT LIMITED TO, THE IMPLIED WARRANTY OF MERCHANTABILITY, FITNESS FOR A PARTICULAR PURPOSE, OR NON-INFRINGEMENT. IN NO EVENT SHALL ATMEL BE LIABLE FOR ANY DIRECT, INDIRECT, CONSEQUENTIAL, PUNITIVE, SPECIAL OR INCIDENTAL DAMAGES (INCLUDING, WITHOUT LIMITATION, DAMAGES FOR LOSS OF PROFITS, BUSINESS INTERRUPTION, OR LOSS OF INFORMATION) ARISING OUT OF THE USE OR INABILITY TO USE THIS DOCUMENT, EVEN IF ATMEL HAS BEEN ADVISED OF THE POSSIBILITY OF SUCH DAMAGES.** Atmel makes no representations or warranties with respect to the accuracy or completeness of the contents of this document and reserves the right to make changes to specifications and product descriptions at any time without notice. Atmel does not make any commitment to update the information contained herein. Unless specifically provided otherwise, Atmel products are not suitable for, and shall not be used in, automotive applications. Atmel's products are not intended, authorized, or warranted for use as components in applications intended to support or sustain life.

© Atmel Corporation 2005. All rights reserved. Atmel®, logo and combinations thereof, Everywhere You Are® and others, are registered trademarks or trademarks of Atmel Corporation or its subsidiaries. Other terms and product names may be trademarks of others.



Printed on recycled paper.

0453H-PLD-7/05