

Welcome to [E-XFL.COM](#)

Embedded - Microcontrollers - Application Specific: Tailored Solutions for Precision and Performance

Embedded - Microcontrollers - Application Specific represents a category of microcontrollers designed with unique features and capabilities tailored to specific application needs. Unlike general-purpose microcontrollers, application-specific microcontrollers are optimized for particular tasks, offering enhanced performance, efficiency, and functionality to meet the demands of specialized applications.

What Are Embedded - Microcontrollers - Application Specific?

Application specific microcontrollers are engineered to

Details

Product Status	Not For New Designs
Applications	Trusted Platform Module (TPM)
Core Processor	16-Bit
Program Memory Type	-
Controller Series	-
RAM Size	-
Interface	LPC
Number of I/O	2
Voltage - Supply	3.3V
Operating Temperature	0°C ~ 70°C
Mounting Type	Surface Mount
Package / Case	28-TSSOP (0.173", 4.40mm Width)
Supplier Device Package	PG-TSSOP-28
Purchase URL	https://www.e-xfl.com/product-detail/infineon-technologies/slb9635tt12fw317xuma1

TPM 1.2

SLB 9635 TT 1.2

The Trusted Platform Module Solution



INFINEON'S TPM Security Solution provides a comprehensive hardware and software solution for safer computing targeted for today's notebook and desktop architectures.

As internet-based communication and commerce has rapidly developed in the past few years, the need for enhanced platform-based system security has grown as well. With the emergence of e-commerce and an increased reliance on the internet for all forms of communication, businesses, and consumers alike are in greater need of assurance that communication is trustworthy.

The Trusted Computing Group (TCG) was founded in 2003 and is continuing the efforts of the Trusted Computing Platform Alliance (TCPA) to address these issues and to allow for continued growth of the internet, computing-based communications and commerce models. The TCG has more than 120 member companies and developed both hardware and software security standards to address today's need for strong platform computing-based security and management.

The Trusted Computing Group (TCG) defined the latest version 1.2 of their standard according to the requirements of the next generation operating system Microsoft Windows Vista.

The Infineon TPM 1.2 is based on the company's proven 16-bit security controller architecture, including non-volatile memory, hardware-based cryptographic implementations of RSA (2048 bit keys) and Hash algorithms. A true Random Number Generator required by the Trusted Computing Group specification is embedded as well. Infineon security controllers based on this architecture have achieved the industry's highest rating for digital security, the Common Criteria EAL 5 high Certificate issued by the German government agency responsible for security in information technology.



In addition to the secure controller, Infineon provides computer manufacturers with a complete TCG solution that includes all required hardware, software, and management utilities to develop a complete platform security solution from one source.

Software application support for Single Sign-On, E-Wallet, Secure E-mail, Personal Secure Drive and Digital Signature completes the Infineon package. In addition the TPM Software Partner Program enables a broad range of security applications to use the benefits of the Infineon TPM.

In conjunction with an on-going commitment to providing security solutions, Infineon Technologies will continue to provide complete solutions that will guarantee the adoption of tomorrow's technologies today.

www.infineon.com/tpm

Trusted Computing



Never stop thinking

Hardware Features of the TPM 1.2

- TCG 1.2 compliant trusted platform module (TPM)
- Security architecture based on Infineon SLE66CXxxPE security controller family
- 16-bit microcontroller in 0.22 µm CMOS technology
- TCG 1.2 compliant embedded software
- EEPROM for TCG firmware enhancements and for user data and keys
- Advanced Crypto Engine (ACE) with RSA support up to 2048 bit key length
- Hardware accelerator for SHA-1 hash algorithm
- True Random Number Generator (TRNG)
- Tick counter with tamper detection
- Protection against Dictionary Attack
- Infineon's TPM 1.2 will be certified at Evaluation Assurance Level (EAL) 4 Medium at TÜViT Labs in Germany
- General Purpose Input/Output
- Intel® Trusted Execution Technology Support
- AMD® Secure Virtual Machine Architecture Support
- Microsoft's recommended GPIO included
- Full personalization with Endorsement Key (EK) and EK certificate
- Power saving sleep mode
- 3.3 V power supply
- WHQL dual mode 1.1b + 1.2 TPM Windows Kernel Mode Driver
- Operating temperature range: 0°C to +70°C

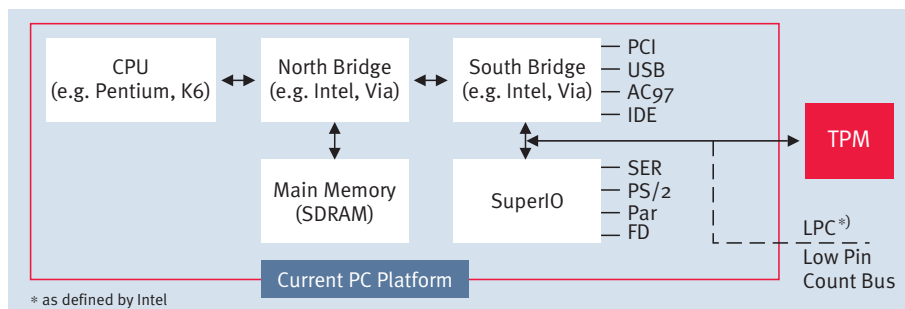
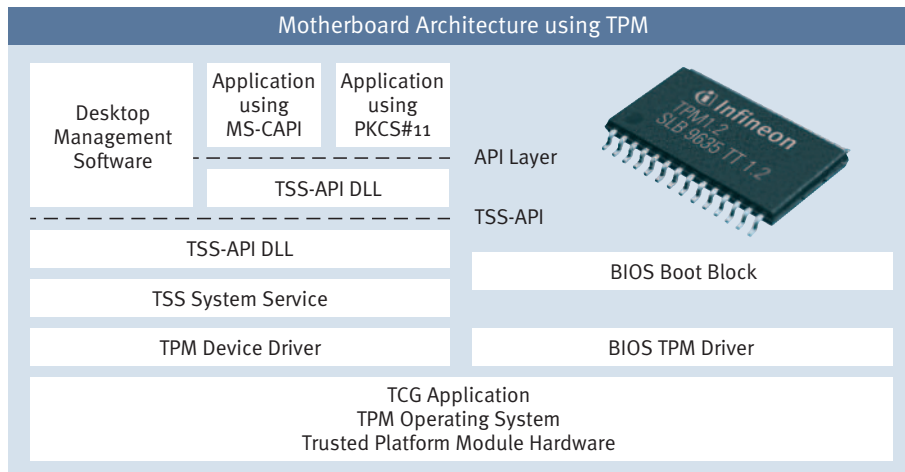

Note:
 Microsoft Outlook, Outlook Express, Explorer and Windows are registered trademarks of Microsoft Corporation.
 Netscape Communicator is a registered trademark of Netscape Communications Corporation.
 RSA SecureID is registered trademarks of RSA Security Inc.
 Check Point, the Check Point logo, OPSEC, VPN-1 SecureClient, and VPN-1 SecuRemote are trademarks or registered trademarks of Check Point Software technologies Ltd. or its affiliates.
 GemSafe for TPM is a registered trademark of Gemalto.

Interfaces

- Low Pin Count (LPC) interface to allow easy system integration
- Operates from a single 33 MHz clock
- Support of power down signal to enter low-power standby mode
- Support of dynamic clock shutdown (CLKRUN)

Package

- Small Low profile TSSOP-28 package
- Green package

Security Features

- Over/Under voltage Detection
- Low frequency sensor
- High frequency filter
- Reset filter
- Memory Encryption (MED)
- Additional security features

Software Features

- Embedded secure operating system
- Embedded TCG application
- Reference implementation for PC-BIOS integration
- TPM Professional Package (supporting Windows 2000, Windows XP Home, Windows® XP Professional, Windows XP Tablet, Windows 2000/2003 Server Windows Vista, Linux driver)
 - TSS software stack compliant to TCG specifications
 - TPM Cryptographic Service Provider (CSP)
 - Infineon's desktop management software for policy enforcement and security feature management

Support of MS-CAPI and PKCS#11 Applications

- Microsoft Outlook® and Outlook Express®
- Microsoft Office 2000, Office XP and Office 2003
- Microsoft Internet Explorer®
- Netscape Communicator®
- Microsoft Encrypted File System
- RSA Secure ID®
- Check Point™ SecuRemote/SecureClient
- Check Point™ VPN-1®/FireWall-1 NG®
- Entrust™ Desktop Manager Solutions
- GemSafe for TPM /Smart Card



How to reach us:
<http://www.infineon.com>

Published by
Infineon Technologies AG
 81726 Munich, Germany

© Infineon Technologies AG 2006.
 All Rights Reserved.

Legal Disclaimer

The information given in this Product Brief shall in no event be regarded as a guarantee of conditions or characteristics ("Beschaffenheitsgarantie"). With respect to any examples or hints given herein, any typical values stated herein and/or any information regarding the application of the device, Infineon Technologies hereby disclaims any and all warranties and liabilities of any kind, including without limitation warranties of non-infringement of intellectual property rights of any third party.

Information

For further information on technology, delivery terms and conditions and prices please contact your nearest Infineon Technologies Office (www.infineon.com).

Warnings

Due to technical requirements components may contain dangerous substances. For information on the types in question please contact your nearest Infineon Technologies Office.
 Infineon Technologies Components may only be used in life-support devices or systems with the express written approval of Infineon Technologies, if a failure of such components can reasonably be expected to cause the failure of that life-support device or system, or to affect the safety or effectiveness of that device or system.
 Life support devices or systems are intended to be implanted in the human body, or to support and/or maintain and sustain and/or protect human life. If they fail, it is reasonable to assume that the health of the user or other persons may be endangered.

Ordering No. B116-H7956-G7-X-7600
 Printed in Germany
 PS 11061. nb